

Perfection V19/V39 User's Guide

Contents

Perfection V19/V39 User's Guide	7
Scanner Basics.....	8
Scanner Parts	8
Scanner Buttons and Lights	11
Using the Scanner Stand	11
Placing Originals on the Scanner	16
Placing Originals on the Scanner Glass	16
Placing Originals While Using the Scanner Stand	19
Placing Thick Documents	23
Scanning	24
Starting a Scan.....	24
Starting a Scan from a Scanner Button.....	24
Changing Default Scan Button Settings	26
Starting a Scan Using the Epson Scan Icon	27
Scanning with Document Capture Pro or Document Capture.....	28
Starting a Scan from a Scanning Program.....	31
Selecting Epson Scan Settings	32
Scan Modes.....	33
Selecting the Scan Mode.....	34
Scanning in Full Auto Mode	34
Available Image Adjustments - Full Auto Mode	37
Scanning in Home Mode	37
Selecting a Scan Area - Home Mode	39
Available Image Adjustments - Home Mode	42
Scanning in Office Mode.....	43
Selecting a Scan Area - Office Mode	45
Available Image Adjustments - Office Mode	47
Scanning in Professional Mode	48
Available Image Types - Professional Mode	50
Available Image Adjustments - Professional Mode	51

Selecting a Scan Size - Professional Mode.....	53
Image Preview Guidelines.....	56
Scan Resolution Guidelines	56
Selecting Scan File Settings.....	58
Available Scanned File Types and Optional Settings.....	59
Scanning Special Projects.....	60
Scanning to Online Destinations Using Easy Photo Scan	60
Scanning Using Easy Photo Scan	61
Uploading Scanned Images to Facebook	63
Uploading Scanned Images to Google Photos	65
Uploading Scanned Images to Evernote.....	67
Uploading Scanned Images to SugarSync	69
Uploading Scanned Images to a Web Folder.....	71
Uploading Scanned Images to Email	73
Saving Scanned Images to a Folder	74
Epson JPEG File Settings.....	75
Epson TIFF and Multi-TIFF File Settings	76
Restoring Photo Colors as You Scan	77
Scanning to a SharePoint Server or Cloud Service	78
Scanning Multi-Page Originals as Separate Files - Windows	80
Stitching Two Images in Epson ScanSmart.....	82
Scanning to a PDF File Using a Scanner Button	85
Available Image Adjustments - Scan to PDF Settings.....	89
Using the Scanner as a Copier - Copy Utility	90
Cleaning and Transporting Your Scanner.....	94
Cleaning Your Scanner	94
Transporting Your Scanner	94
Solving Problems	96
Scanner Light Status	96
Solving Scanning Problems	97
Scanner Does Not Turn On or Turns Off Unexpectedly.....	97
Scanner Buttons Do Not Work as Expected	98
Scanning Software Does Not Operate Correctly	98

Cannot Start Epson Scan	99
Scanning is Slow	99
Cannot Scan Using Thumbnail Preview	100
Solving Scanned Image Quality Problems	100
Image Consists of a Few Dots Only	100
Line of Dots Appears in All Scanned Images	101
Straight Lines in an Image Appear Crooked	101
Image is Distorted or Blurry	101
Image Colors are Patchy at the Edges	101
Image is Too Dark	102
Back of Original Image Appears in Scanned Image	102
Ripple Patterns Appear in an Image	102
Image is Scanned Upside-Down	102
Scanned Image Colors Do Not Match Original Colors	103
Scan Area is Not Adjustable in Thumbnail Preview	103
Scanned Image Edges are Cropped	104
Characters are not Recognized During Conversion to Editable Text (OCR)	104
Uninstall Your Scanner Software.....	104
Uninstalling Scanner Software - Windows.....	104
Uninstalling Scanner Software - Mac.....	105
Where to Get Help.....	106
Technical Specifications	107
Windows System Requirements	107
Mac System Requirements	107
General Specifications	108
Dimension Specifications	108
Electrical Specifications	109
Environmental Specifications	109
USB Interface Specifications.....	109
Safety and Approvals Specifications	110
Notices	111
Important Safety Instructions.....	111
Default Delay Times for Power Management for Epson Products.....	112

Restrictions on Copying	112
Trademarks	113
Copyright Notice.....	113
libTIFF Software Acknowledgment.....	114
A Note Concerning Responsible Use of Copyrighted Materials.....	114
Copyright Attribution	115

Perfection V19/V39 User's Guide

Welcome to the Perfection V19/V39 *User's Guide*.

For a printable PDF copy of this guide, [click here](#).

Scanner Basics

See these sections to learn about the basic features of your scanner.

[Scanner Parts](#)

[Scanner Buttons and Lights](#)

[Using the Scanner Stand](#)

Scanner Parts

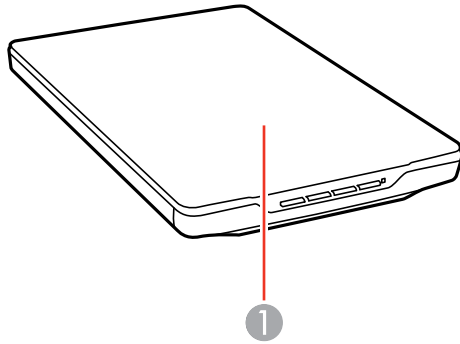

1 Scanner cover

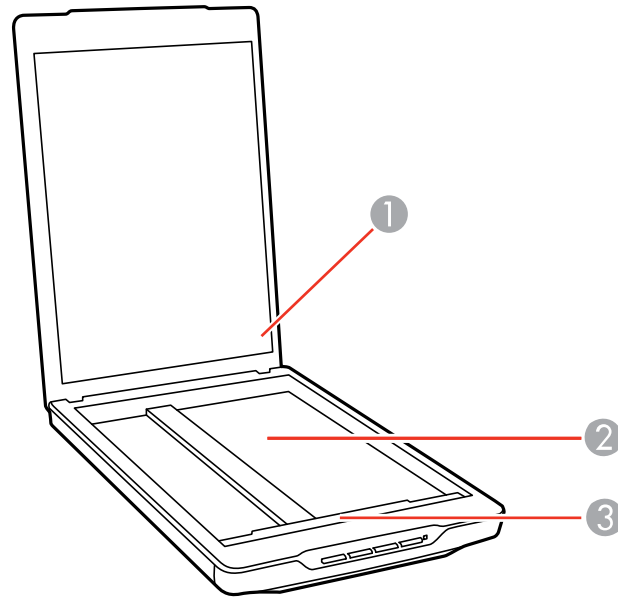

- 1 Document mat
- 2 Scanner glass
- 3 Carriage (beneath scanner glass)

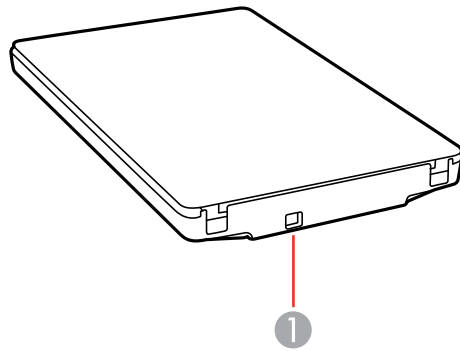

1 USB port

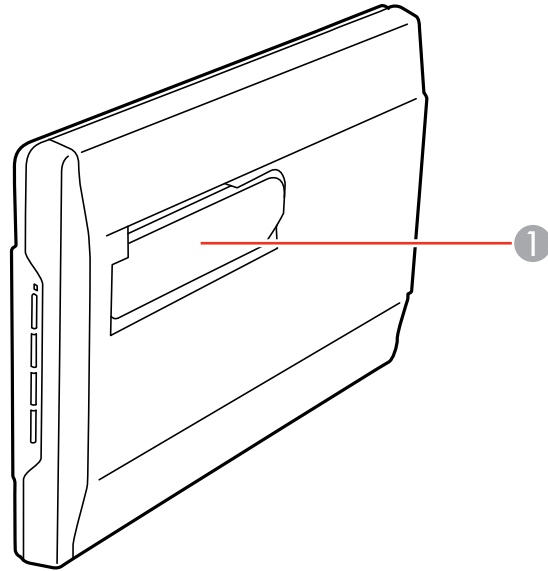



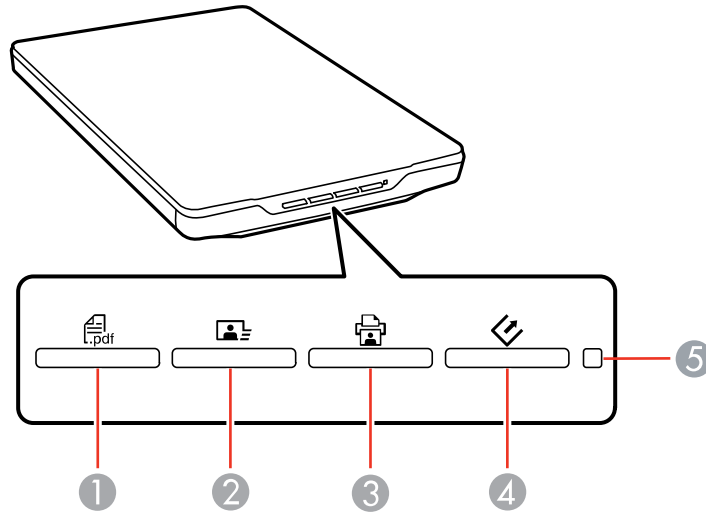

1 Scanner stand

Parent topic: [Scanner Basics](#)

Scanner Buttons and Lights



- 1 The  PDF button
- 2 The  send button
- 3 The  copy button
- 4 The  start button
- 5 The status light

Parent topic: [Scanner Basics](#)

Related references
[Scanner Light Status](#)

Using the Scanner Stand

The scanner can be used in an upright position if surface space is limited.

1. Stand the scanner upright.

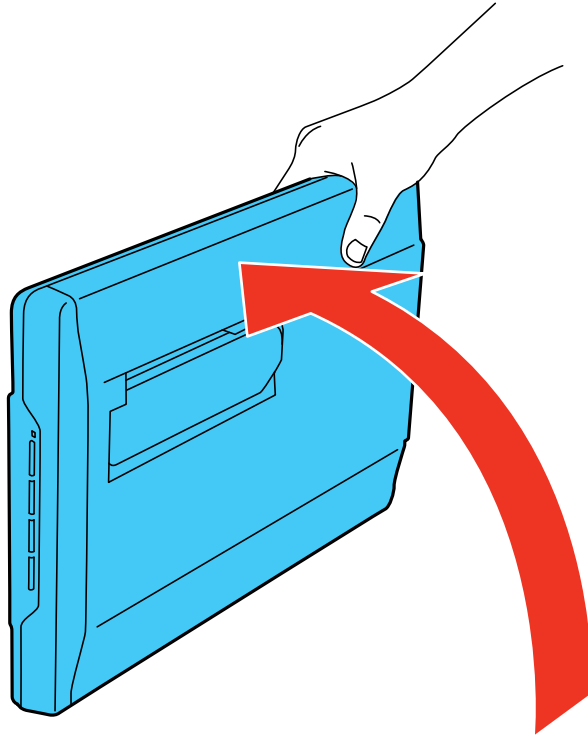

2. Extend the scanner stand from the back of the scanner until it clicks into place.

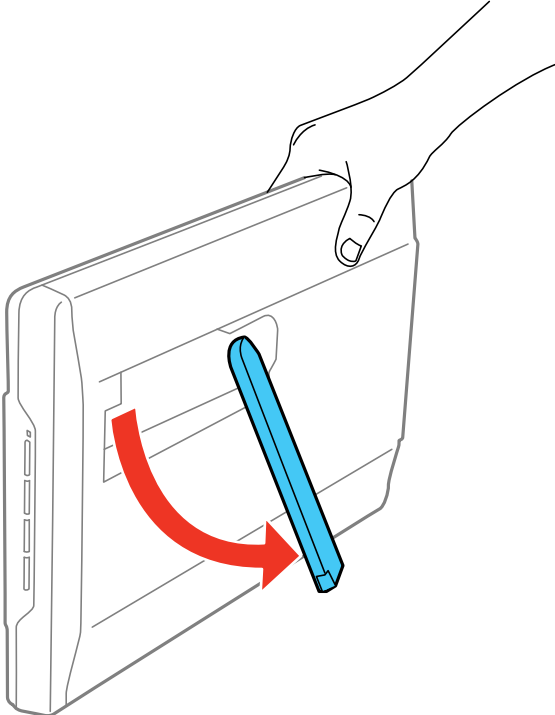

3. Tilt the scanner until it rests on the scanner stand.

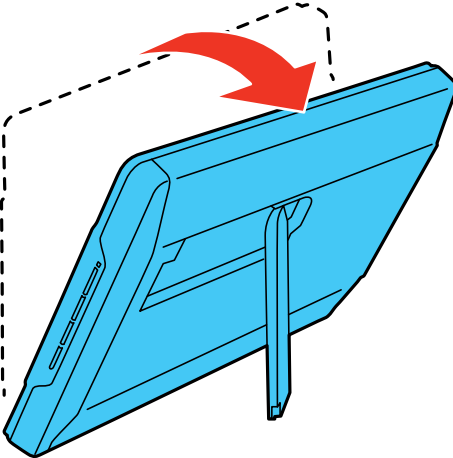

4. To put the scanner stand away, rotate it into the back of the scanner.

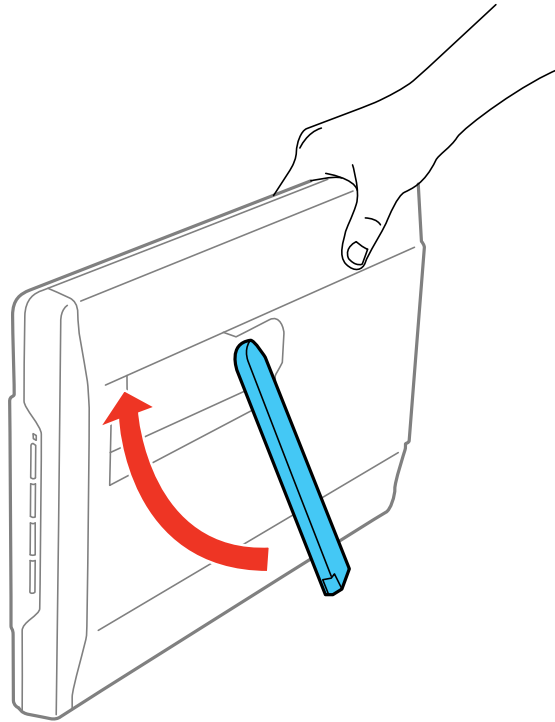

Parent topic: [Scanner Basics](#)

Placing Originals on the Scanner

Follow the instructions here to place your originals on the scanner.

Caution: Do not place anything on top of your scanner or use its cover as a writing surface to avoid damaging it.

[Placing Originals on the Scanner Glass](#)

[Placing Originals While Using the Scanner Stand](#)

[Placing Thick Documents](#)

Placing Originals on the Scanner Glass

You can place originals directly on the scanner glass.

Caution: Do not place heavy objects on the scanner glass and do not press on the glass with too much force, or it may damage the scanner. Do not leave photos on the scanner glass for an extended period, or they may stick to the glass.

1. Open the scanner cover.

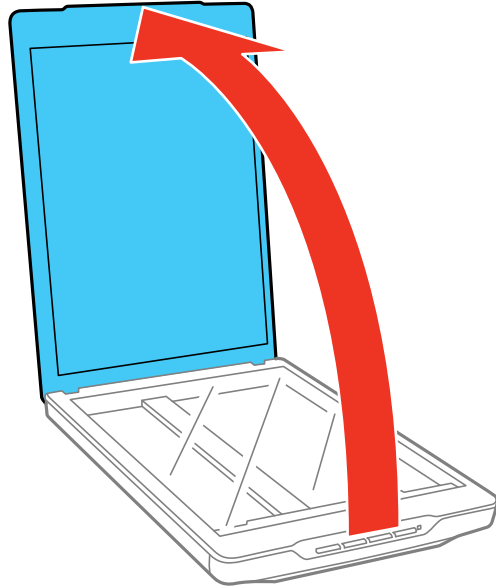

2. Place your original facedown on the scanner glass with the top edge facing as shown. Slide the original to the edges of the indicated corner.

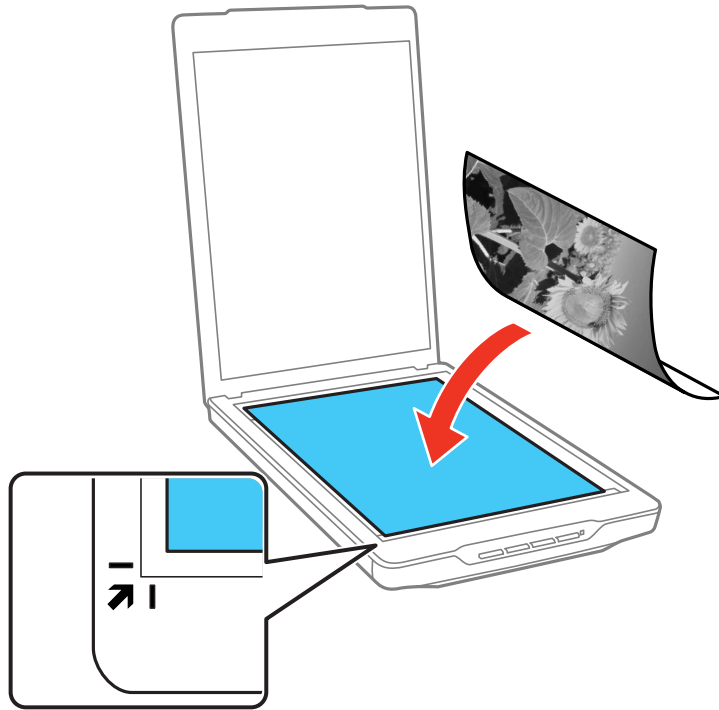

Note: You can place multiple originals on the scanner glass. Make sure they are at least 0.8 inch (20 mm) away from each other.

Note: The edges of your original may be cropped by 0.1 inch (2.5 mm) from the left side and top edges. If you are scanning in Full Auto mode or using thumbnail preview in another mode in Epson

Scan, the edges of your original may be cropped by about 0.24 inch (6 mm) from the top and side edges. Manually position your original away from the edges to prevent cropping.

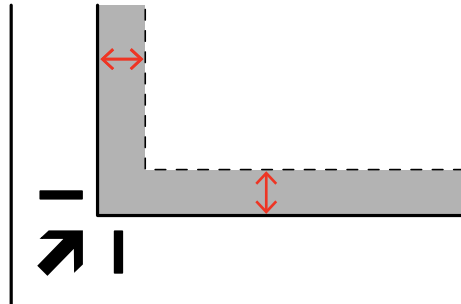

3. Close the scanner cover gently to keep your original in place.

Parent topic: [Placing Originals on the Scanner](#)

Related tasks

[Scanning in Full Auto Mode](#)

Placing Originals While Using the Scanner Stand

You can place originals directly on the scanner glass while the scanner stand is extended.

Caution: Do not place heavy objects on the scanner glass and do not press on the glass with too much force, or it may damage the scanner. Do not leave photos on the scanner glass for an extended period, or they may stick to the glass.

Note: You cannot place large or thick documents when the scanner is in a standing position.

1. Open the scanner cover.

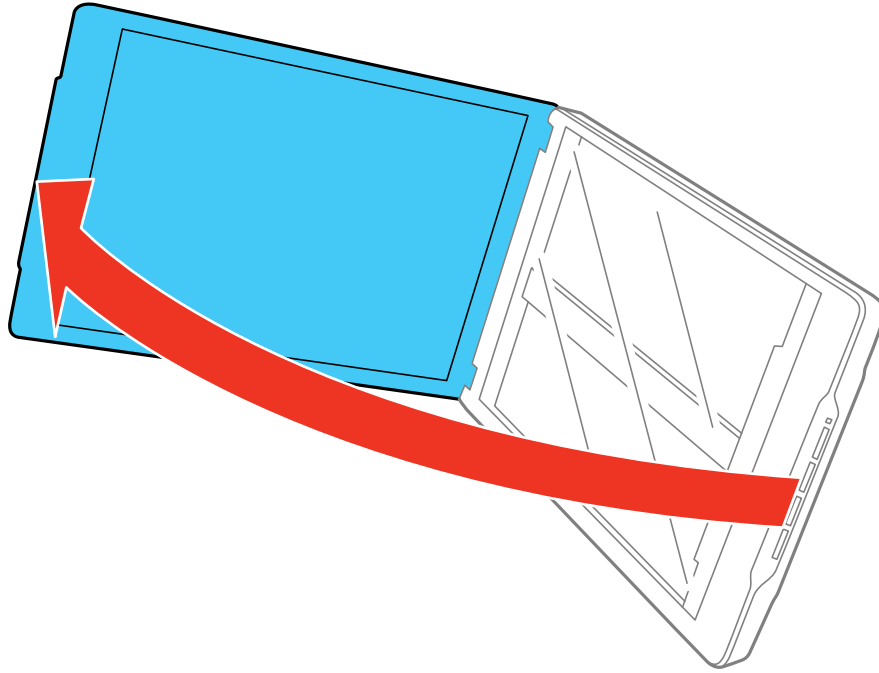

2. Place your original facedown on the scanner glass with the top edge facing as shown. Slide the original to the edges of the indicated corner.

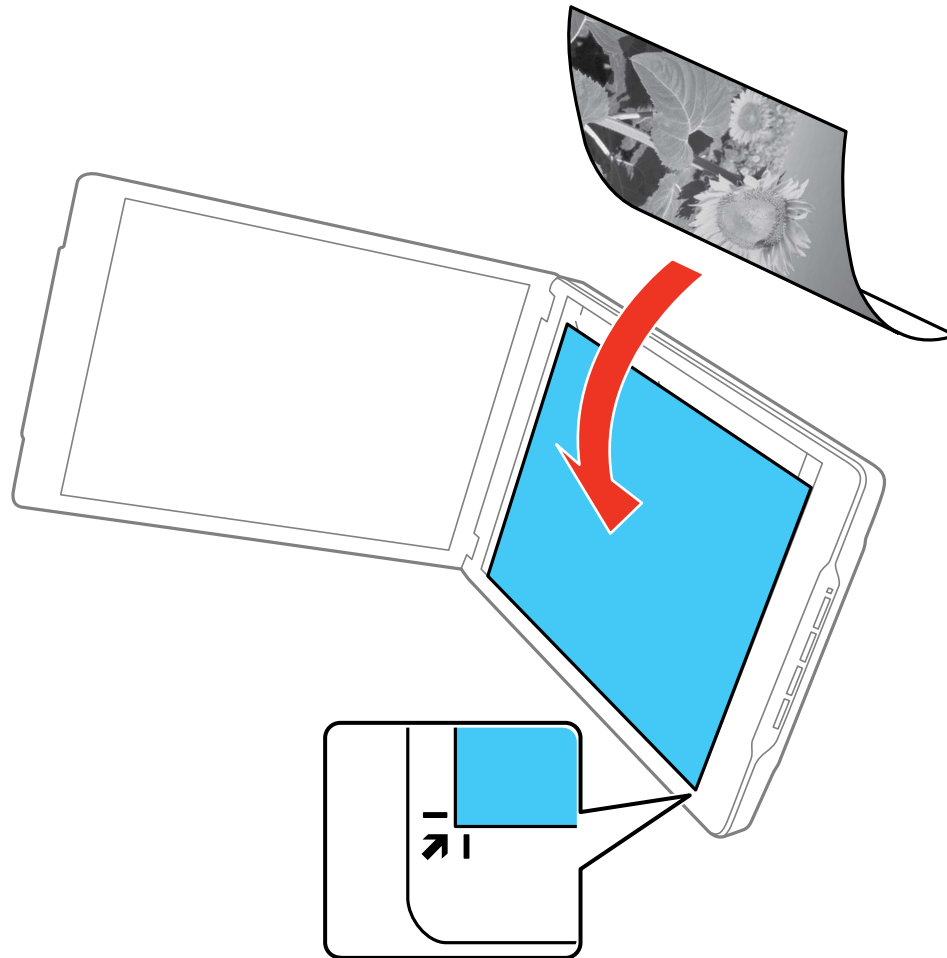

Note: The edges of your original may be cropped by 0.1 inch (2.5 mm) from the left side and top edges. If you are scanning in Full Auto mode or using thumbnail preview in another mode in Epson

Scan, the edges of your original may be cropped by about 0.24 inch (6 mm) from the top and side edges.

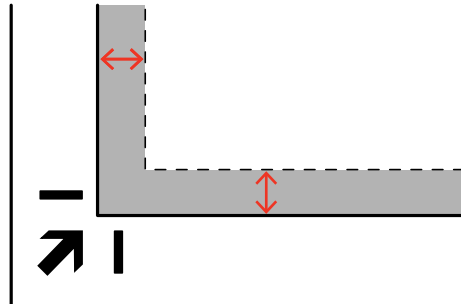

3. Close the scanner cover gently and hold it to keep your original in place.

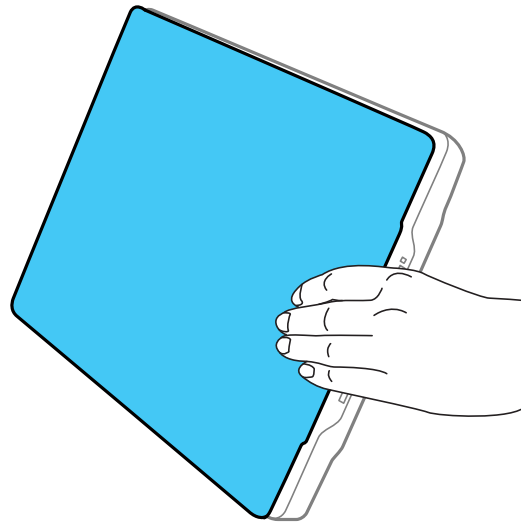

Parent topic: [Placing Originals on the Scanner](#)

Related tasks

[Using the Scanner Stand](#)

Placing Thick Documents

If you are scanning a book or other thick document, you can remove the scanner cover.

1. Hold the scanner cover near the hinges and pull straight up, keeping the cover horizontal.

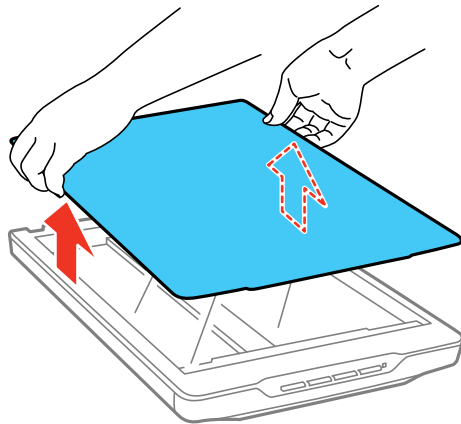

2. Place your document facedown on the scanner glass.

Note: Press down on your document gently to flatten it and hold the document down as you scan.

3. When you are finished scanning, replace the scanner cover in the reverse order that you removed it.

Parent topic: [Placing Originals on the Scanner](#)

Scanning

You can scan your originals and save them as digital files.

[Starting a Scan](#)

[Selecting Epson Scan Settings](#)

[Scanning Special Projects](#)

Starting a Scan

After placing your originals on your product for scanning, start scanning using one of these methods.

[Starting a Scan from a Scanner Button](#)

[Starting a Scan Using the Epson Scan Icon](#)

[Scanning with Document Capture Pro or Document Capture](#)

[Starting a Scan from a Scanning Program](#)

Parent topic: [Scanning](#)

Starting a Scan from a Scanner Button





You can scan using a button on your scanner. This automatically starts a default scanning program, but you can reassign the buttons to different programs.

Your product automatically selects suitable default scan settings, but you can view or change them as necessary.

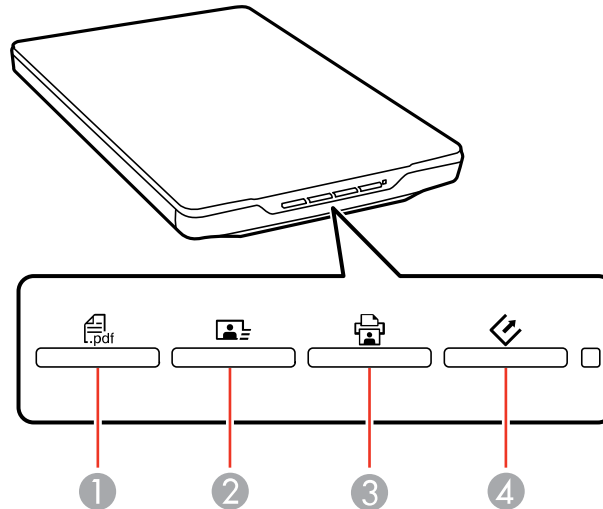
1. Make sure you installed the scanner software and connected the scanner to your computer or network.
2. Place the original on your scanner.

3. Press one of the following buttons on your scanner:



- 1 The  PDF button starts the Scan to PDF utility so you can scan multiple originals directly to a PDF file
- 2 The  send button starts Easy Photo Scan so you can scan your original and send it by email or upload it to a cloud destination.
- 3 The  copy button starts the Copy Utility so you can scan your original and print it on a printer connected to your computer
- 4 The  start button starts Epson Scan so you can select your scan mode, settings, and scanned file destination on your computer

The designated scan program starts.

[Changing Default Scan Button Settings](#)

Parent topic: [Starting a Scan](#)

Related tasks

[Placing Originals on the Scanner Glass](#)

[Placing Originals While Using the Scanner Stand](#)

[Scanning to a PDF File Using a Scanner Button](#)
[Using the Scanner as a Copier - Copy Utility](#)

Related topics

[Scanning to Online Destinations Using Easy Photo Scan](#)
[Selecting Epson Scan Settings](#)

Changing Default Scan Button Settings

You can view or change the default program and actions performed by each scanner button. You do this using the Event Manager program.

1. Do one of the following to open Event Manager:
 - **Windows 8.x:** Navigate to the **Apps** screen and select **Event Manager**.
 - **Windows (other versions):** Click  or **Start > All Programs** or **Programs > Epson Software > Event Manager**.
 - **OS X:** Open the **Applications** folder, click **Epson Software**, and click **Event Manager**.

You see a window like this:

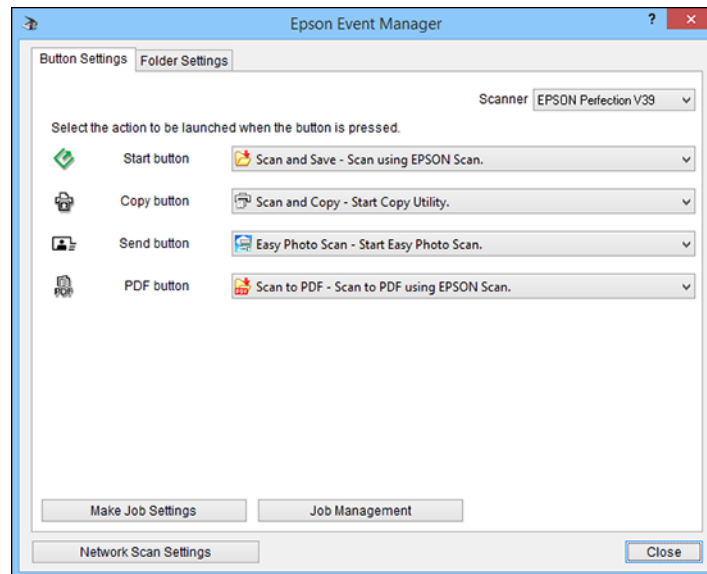

2. Change the program and action performed by each button as necessary.

3. Click **Close** to close the Event Manager window.

Parent topic: [Starting a Scan from a Scanner Button](#)

Starting a Scan Using the Epson Scan Icon

You can start the Epson Scan program to select scan settings, scan, and save the scanned image to a file.

- **Windows 8.x:** Navigate to the **Apps** screen and select **EPSON Scan** under **EPSON** or **EPSON Software**.
- **Windows (other versions):** Click  or **Start**, and select **All Programs** or **Programs**. Select **EPSON** or **EPSON Software** and click **EPSON Scan**.
- **Mac:** Open the **Applications** folder, open the **Epson Software** folder, and double-click the **EPSON Scan** icon.

Note: On a Mac, in addition to scanning with Image Capture, you can download and install Epson Scan scanning software. Epson Scan provides additional image adjustment and photo correction features for enhancing scanned images, and provides an interface for TWAIN-compliant OCR scanning software. To download Epson Scan, visit Epson's driver download site at epson.com/support (U.S) or epson.ca/support (Canada) and select your product.

Note: On a Mac, if you see a message asking if you want to use TWAIN to scan with your product, select **Yes** to scan using Epson Scan.

You see an Epson Scan window like this:

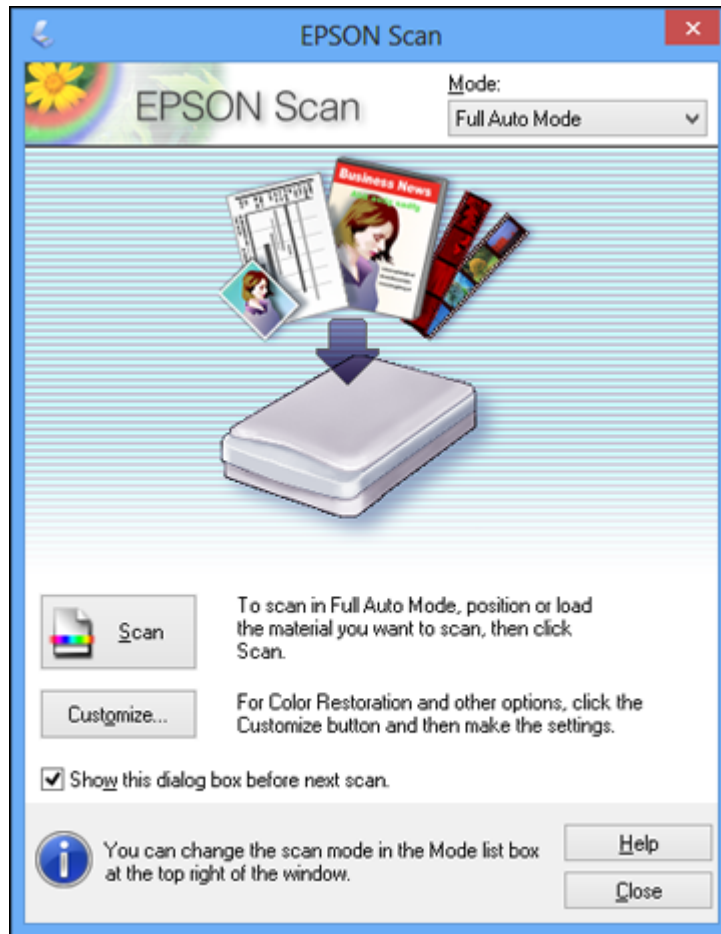



Parent topic: [Starting a Scan](#)

Scanning with Document Capture Pro or Document Capture

When you scan with Document Capture Pro (Windows) or Document Capture (Mac), the program automatically saves your scanned file on your computer in the folder you specify. You can select settings, preview, and change the scanned file settings as necessary.

Note: The settings may vary, depending on the software version you are using. See the Help information in Document Capture or Document Capture Pro for details.

1. Do one of the following to start Document Capture Pro (Windows) or Document Capture (Mac):
 - **Windows 10:** Click  and select **Epson Software > Document Capture Pro**.
 - **Windows 8.x:** Navigate to the **Apps** screen and select **Document Capture Pro**.
 - **Windows (other versions):** Click  or **Start**, and select **All Programs** or **Programs**. Select **Epson Software > Document Capture Pro**.
 - **Mac:** Open the **Applications** folder, open the **Epson Software** folder, and select **Document Capture**.
2. Select **Switch to Standard View**, if necessary.

You see a window like this:

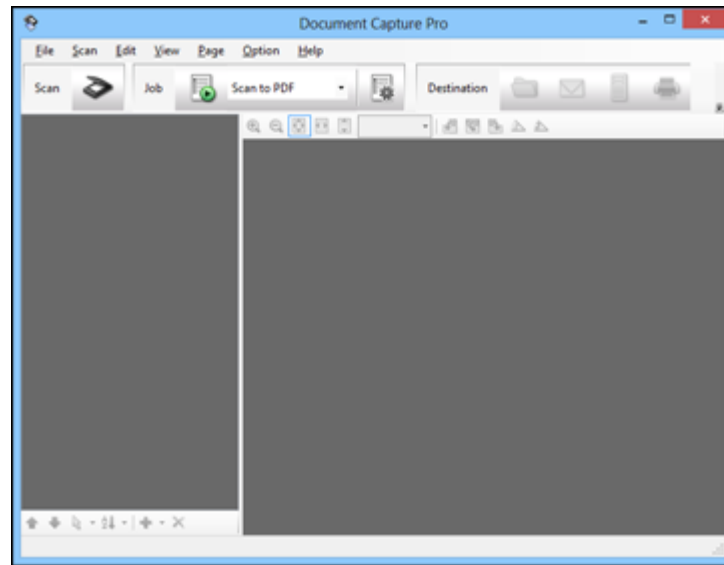

3. Click the  **Scan** icon.

You see a window like this:

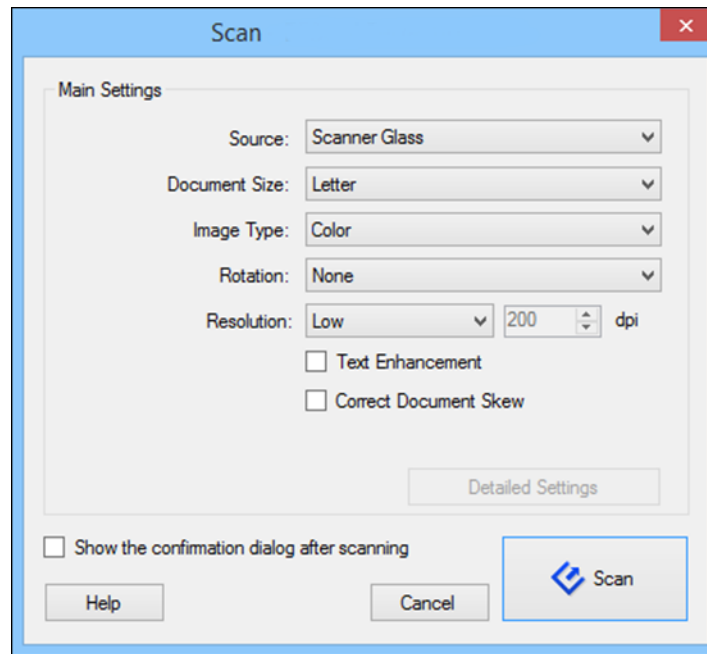



Note: If you want to use a scan job that you created instead, select it from the Job list in the Document Capture Pro or Document Capture window, click the  Start Job button, and skip the rest of these steps.

Note: If you selected **Use EPSON Scan** in the **Scan** menu under **Scan Settings Screen**, the Epson Scan main window opens instead of the Scan screen.

4. Select any displayed scan settings you want to use.

Note: See the Help information in Document Capture Pro or Document Capture for details.

5. If you want to select detailed scan settings, do one of the following:
 - **Windows:** Close the Scan window. Open the **Scan** menu at the top of the screen, select **Scan Settings Screen**, and choose **Use EPSON Scan**. Click the  Scan icon. Choose the Epson Scan mode and select any displayed scan settings you want to use.

- **Mac:** Close the Scan window. Open the **Scan** menu at the top of the screen and select **Displays the EPSON Scan Setup Screen**. Click the  Scan icon. Select any displayed scan settings you want to use and click **OK**.
6. If you selected detailed scan settings, click **Preview**.
You see a preview of your scan in the Epson Scan window.
 7. Click **Scan**.
You see a preview of your scan in the Document Capture Pro (Windows) or Document Capture (Mac) window.
- Note:** You may have to close the Epson Scan window to view your scan in the Document Capture Pro (Windows) or Document Capture (Mac) window.
8. If you would like to scan additional originals and add them to the current captured images, click the  Add Page button, select **Acquire from Scanner**, and repeat the previous steps.
 9. Check the scanned images and edit them as necessary.
 10. Click one of the Destination icons to choose where to send your scanned files. (If you cannot see all of the icons below, click the arrow next to the icons.)



11. Depending on the destination you chose, click **OK** or **Send** to complete the operation.

Parent topic: [Starting a Scan](#)

Starting a Scan from a Scanning Program

You can start Epson Scan from a TWAIN-compliant scanning program to select scan settings, scan, and open the scanned image in the program.

1. Open your scanning program and select its scanning option. (See your scanning program help for instructions.)
2. Select your product.

Note: In certain programs, you may need to select your product as the "source" first. If you see a **Select Source** option, choose it and select your product.

You see an Epson Scan window like this:

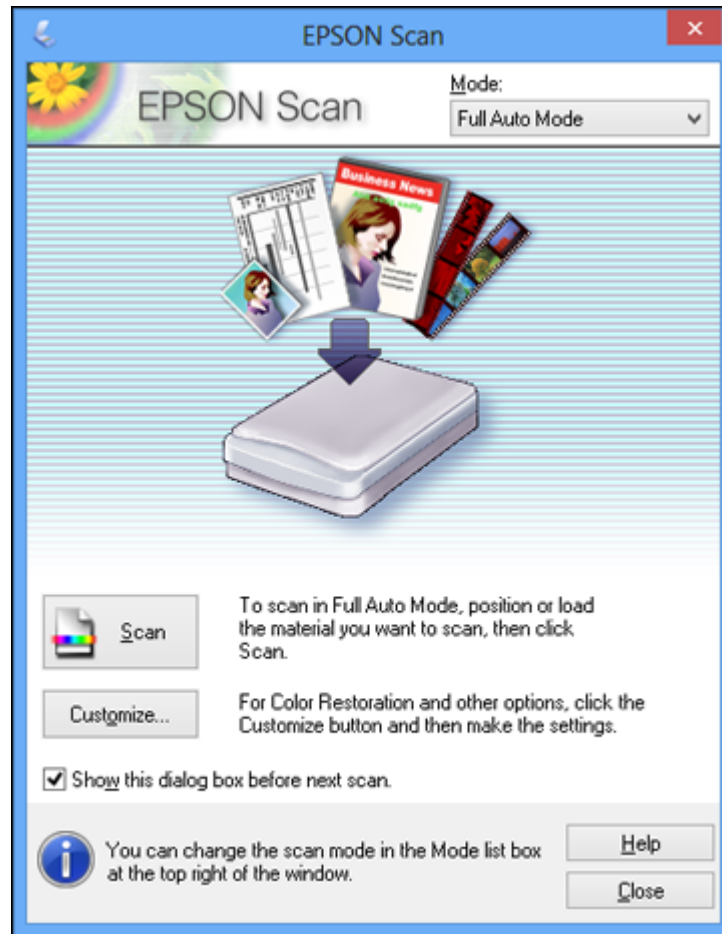

Note: In certain programs, you may see the program's scan window instead of the Epson Scan window. Select scanning options as necessary.

Parent topic: [Starting a Scan](#)

Selecting Epson Scan Settings

After starting Epson Scan, you can select settings in various modes to customize your scan.

[Scan Modes](#)
[Selecting the Scan Mode](#)
[Scanning in Full Auto Mode](#)
[Scanning in Home Mode](#)
[Scanning in Office Mode](#)
[Scanning in Professional Mode](#)
[Image Preview Guidelines](#)
[Scan Resolution Guidelines](#)
[Selecting Scan File Settings](#)
Parent topic: [Scanning](#)

Scan Modes

Epson Scan provides a choice of scan modes with different levels of control over your settings.

Full Auto Mode

This mode automatically detects the type of content you are scanning, selects settings for it, and saves your scanned image. You can also select various image adjustment options.

Home Mode

You can select setting groups based on the type of content you are scanning. You can also select various image adjustment options, and preview and size your scanned image.

Office Mode

You can quickly scan text documents and adjust them on a preview screen. You can also select various image adjustment options and preview your scanned image.

Professional Mode

You can manually customize all available settings, and preview and size your scanned image.

Parent topic: [Selecting Epson Scan Settings](#)

Related tasks

[Scanning in Full Auto Mode](#)
[Scanning in Home Mode](#)
[Scanning in Office Mode](#)
[Scanning in Professional Mode](#)

Selecting the Scan Mode

Select the Epson Scan mode you want to use from the Mode box in the upper right corner of the Epson Scan window:

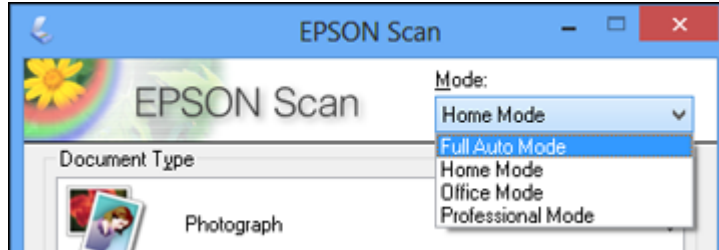

Parent topic: [Selecting Epson Scan Settings](#)

Scanning in Full Auto Mode

When you scan in Full Auto Mode, Epson Scan automatically saves your scanned file in JPEG format in your operating system's Pictures or My Pictures folder, or opens it in your scanning program. You can change the scanned file settings and select various image adjustment options before you scan, if necessary.

1. Start Epson Scan and select **Full Auto Mode** as the Mode setting.

You see this window:

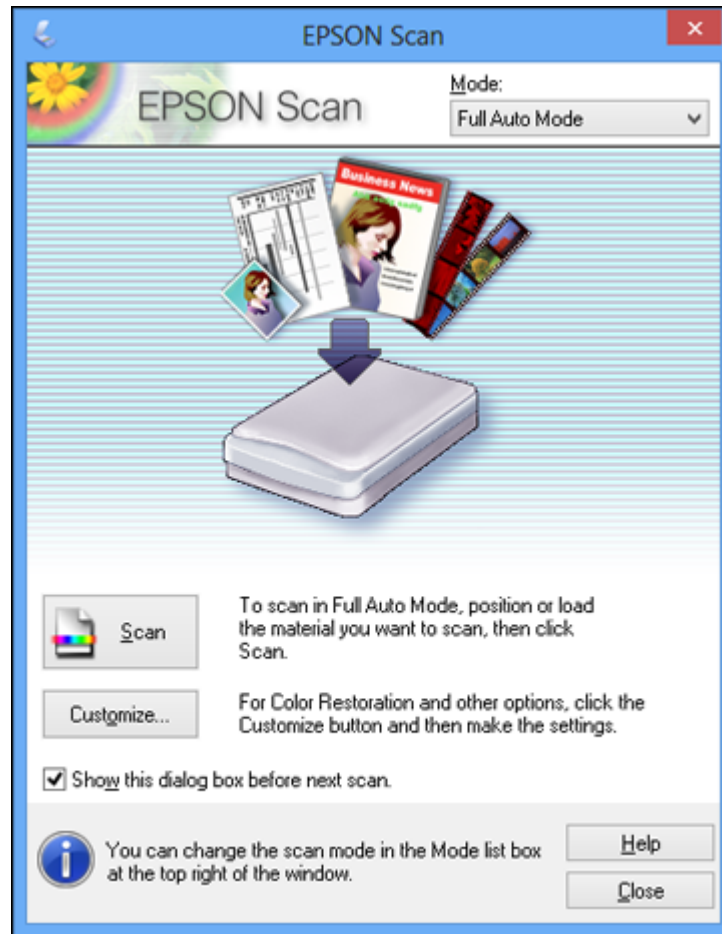

2. To select image adjustment options or change your scanned file settings, click **Customize**, select the settings you want, and click **OK**.

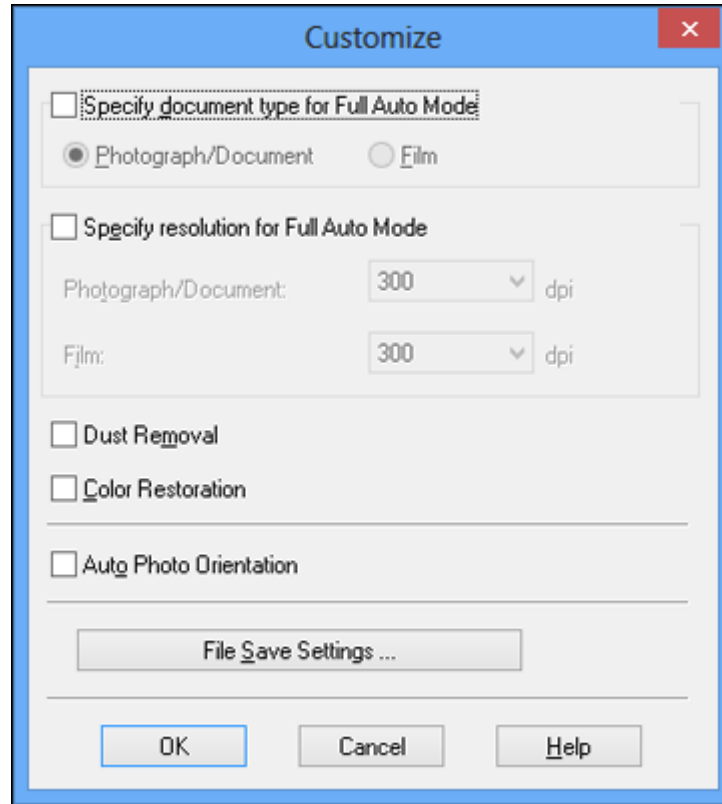

- To choose any of the available image adjustment options, select the checkbox for the option.
- To change the scanned file settings, click **File Save Settings**.

3. Click **Scan**.

Epson Scan scans your original, and saves the file in the selected folder or opens it in your scanning program. If the file was saved directly to your computer, you see the file in the Windows Explorer or Mac Finder, where you can view and print the image, if desired.

[Available Image Adjustments - Full Auto Mode](#)

Parent topic: [Selecting Epson Scan Settings](#)

Related concepts

[Scan Resolution Guidelines](#)

Related tasks

[Selecting Scan File Settings](#)

Available Image Adjustments - Full Auto Mode

You can select these image adjustment options in Epson Scan Full Auto Mode.

Dust Removal

Removes dust marks from your originals automatically.

Color Restoration

Restores the colors in faded photos automatically.

Auto Photo Orientation

Checks the preview image for faces, the sky, and other features, and then correctly rotates the photo when it is scanned, if necessary. (If your photo is not oriented correctly using this option, deselect this option and scan again.)

Parent topic: [Scanning in Full Auto Mode](#)

Scanning in Home Mode

When you scan in Home Mode, Epson Scan automatically saves your scanned file in JPEG format in your operating system's Pictures or My Pictures folder, or opens it in your scanning program. You can select settings, preview, and change the scanned file settings as necessary.

1. Start Epson Scan and select **Home Mode** as the Mode setting.

You see this window:

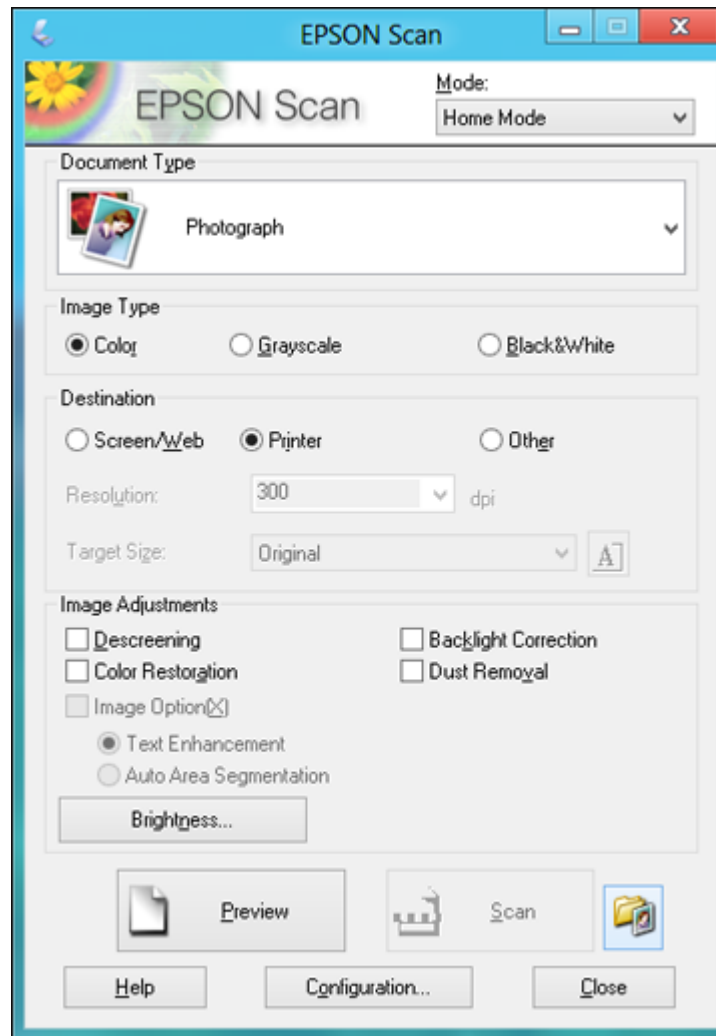

2. Select the **Document Type** setting that matches your original, such as **Photograph** or **Text/Line Art**.
3. Select the **Image Type** setting that matches your original.

4. Select the way you plan to use your scanned image as the **Destination** setting. (The Resolution setting is selected automatically based on the Destination setting you choose.)
 - **Screen/Web**: Select this option for images you will email, view on a computer screen, or post on the web.
 - **Printer**: Select this option for images you will print or documents you will convert to editable text using OCR (Optical Character Recognition) software.
 - **Other**: Select this option if you want to select a custom resolution for your image.
5. If you selected **Other** in the last step, select the **Resolution** setting you want to use for your scan.
6. Click the **Preview** button.

Epson Scan previews your original and displays the result in a separate Preview window.
7. If desired, select the area in your preview image that you want to scan (scan area).
8. Select any of the image adjustment settings you want to use. Before making adjustments, click the image or scan area in the Preview window.
9. If you want to reduce or enlarge your image as you scan, select the **Target Size** setting you want to use.
10. Click **Scan**.

You see the File Save Settings window.
11. Change any of the necessary file save settings and click **OK**.

Epson Scan scans your original, and saves the file in the selected folder or opens it in your scanning program. If the file was saved directly to your computer, you see the file in the Windows Explorer or Mac Finder, where you can view and print the image, if desired.

[Selecting a Scan Area - Home Mode](#)

[Available Image Adjustments - Home Mode](#)

Parent topic: [Selecting Epson Scan Settings](#)

Related concepts

[Scan Resolution Guidelines](#)

Related tasks

[Selecting Scan File Settings](#)

Selecting a Scan Area - Home Mode

You can select a specific area in your preview image to include in your scanned image. You can select the entire image area or a portion of it. You can even select multiple scan areas to create multiple scanned images of different areas (Normal Preview mode only).

You can also use the scan area to select specific Image Adjustments settings for a scanned image. Just be sure to click inside the scan area before selecting the settings.

1. Do one of the following to select your scan area in the Preview image:
 - **Thumbnail preview:** Your scan area is selected automatically, but you can change it. Place your cursor in one corner of the desired scan area, then click and drag the cursor to the opposite corner to create a marquee (dotted line) on the preview image.

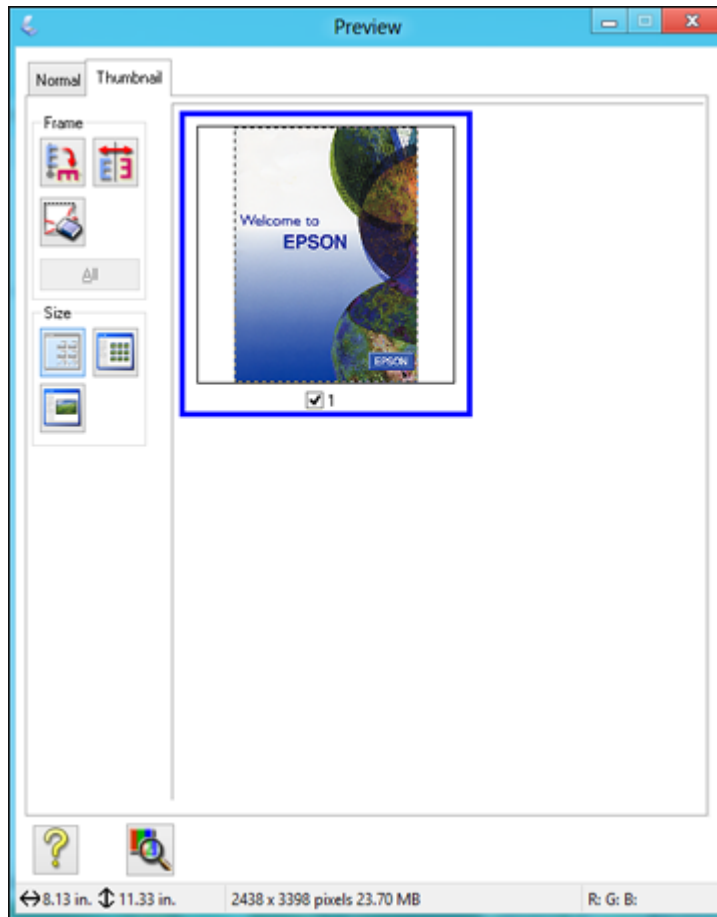

- **Normal preview:** Click the  Auto Locate icon to create a marquee (dotted line) on the preview image.



2. Do the following, as necessary, to work with the selected scan area:
 - If the marquee is correct, continue with the next step.
 - To move the marquee, click inside the scan area and drag the marquee where you want it.
 - To resize the scan area, place your cursor over the edge or corner of the marquee, then click and drag the edges where you want them. (Hold down the **Shift** key as you resize the marquee to retain the same width/height proportions.)

- **Normal preview:** To create additional marquees (up to 50), click the  Copy Marquee icon to copy the existing marquee and paste it on the preview image.

Note: If you draw multiple marquees, make sure you select the **All** button in the Preview window before you scan. Otherwise, only the area inside the currently selected marquee will be scanned.

- To delete a marquee, click the marquee, then click the  Delete Marquee icon.
 - **Thumbnail preview:** To change the preview style, click one of the **Size** icons.
3. Click inside the scan area and make any necessary settings in the Epson Scan window.

Parent topic: [Scanning in Home Mode](#)

Available Image Adjustments - Home Mode

You can select these Image Adjustments options in Epson Scan Home Mode.

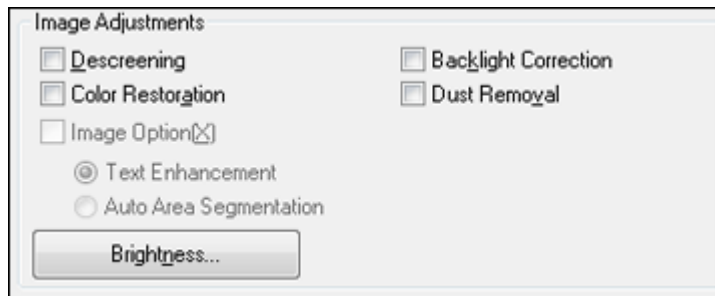

Note: Select the **Image Option** checkbox if you need to set any of the grayed-out image adjustments. Not all adjustment settings may be available, depending on the Document Type and Image Type setting. Click the **Brightness** button to access additional settings.

Descreening

Removes the ripple pattern that might appear in subtly shaded image areas, such as skin tones. This option improves results when scanning magazines or newspapers. (The results of descreening do not appear in the preview image, only in your scanned image.)

Color Restoration

Restores the colors in faded photos automatically.

Backlight Correction

Removes shadows from photos that have too much background light.

Dust Removal

Removes dust marks from your originals automatically.

Text Enhancement

Sharpens the appearance of letters in text documents.

Auto Area Segmentation

Makes grayscale images clearer and text recognition more accurate by separating the text from the graphics.

Brightness

Adjusts the overall lightness and darkness of the scanned image.

Contrast

Adjusts the difference between the light and dark areas of the overall scanned image.

Threshold

Adjusts the level at which black areas in text and line art are delineated, improving text recognition in OCR (Optical Character Recognition) programs.

Parent topic: [Scanning in Home Mode](#)

Scanning in Office Mode

When you scan in Office Mode, Epson Scan automatically saves your scanned file in JPEG format in your operating system's Pictures or My Pictures folder, or opens it in your scanning program. You can select settings, preview, and change the scanned file settings as necessary.

1. Start Epson Scan and select **Office Mode** as the Mode setting.

You see this window:

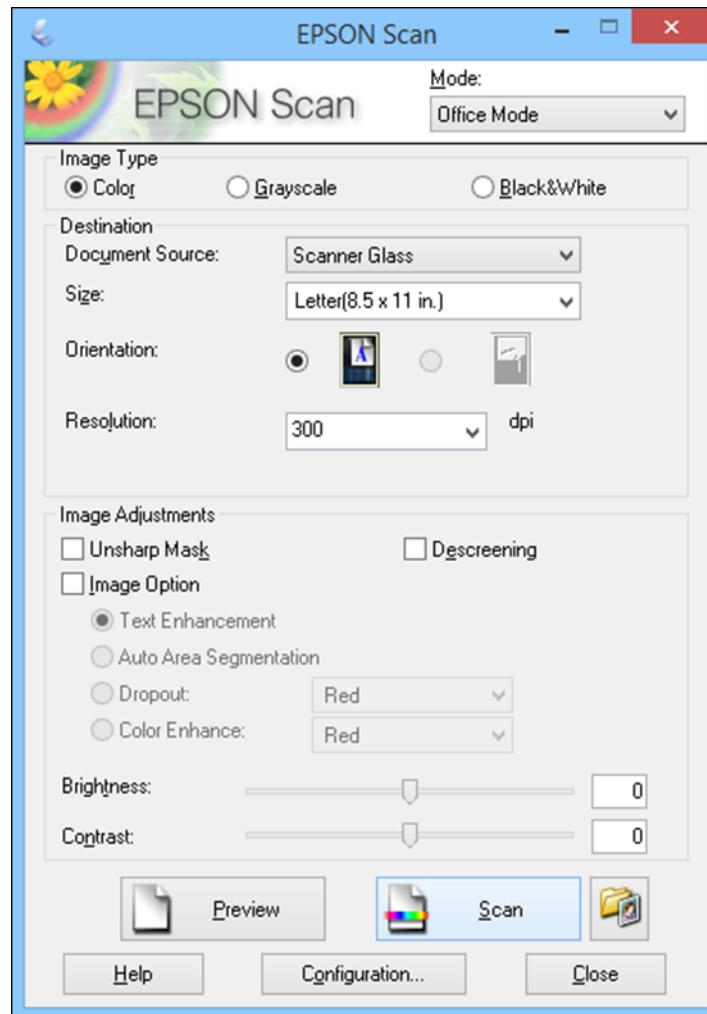

2. Select the **Image Type** setting that matches your original.
3. Select the **Document Source** setting indicating where you placed your original.
4. Select the **Size** and **Orientation** settings that match your original.
5. Select the **Resolution** setting you want to use for your scan.

6. Click the **Preview** button.

Epson Scan previews your original and displays the result in a separate Preview window.

7. If desired, select the area in your preview image that you want to scan (scan area).
8. Select any of the image adjustment settings you want to use. Before making adjustments, click the image or scan area in the Preview window.
9. Click **Scan**.

You see the File Save Settings window.

10. Change any of the necessary file save settings and click **OK**.

Epson Scan scans your original, and saves the file in the selected folder or opens it in your scanning program. If the file was saved directly to your computer, you see the file in the Windows Explorer or Mac Finder, where you can view and print the image, if desired.

[Selecting a Scan Area - Office Mode](#)

[Available Image Adjustments - Office Mode](#)

Parent topic: [Selecting Epson Scan Settings](#)

Related concepts

[Scan Resolution Guidelines](#)

Related tasks

[Selecting Scan File Settings](#)

Selecting a Scan Area - Office Mode

You can select a specific area in your preview image to include in your scanned image. You can select the entire image area or a portion of it. You can even select multiple scan areas to create multiple scanned images of different areas.

You can also use the scan area to select specific Image Adjustments settings for a scanned image. Just be sure to click inside the scan area before selecting the settings.

1. In the Preview window, click the  Auto Locate icon to create a marquee (dotted line) on the preview image.



2. Do the following, as necessary, to work with the selected scan area:
 - If the marquee is correct, continue with the next step.
 - To move the marquee, click inside the scan area and drag the marquee where you want it.

- To resize the scan area, place your cursor over the edge or corner of the marquee, then click and drag the edges where you want them. (Hold down the **Shift** key as you resize the marquee to retain the same width/height proportions.)
- To create additional marquees (up to 50, if available), click the  Copy Marquee icon to copy the existing marquee and paste it on the preview image.

Note: If you draw multiple marquees, make sure you select the **All** button in the Preview window before you scan. Otherwise, only the area inside the currently selected marquee will be scanned.

- To delete a marquee, click the marquee, then click the  Delete Marquee icon.
- To rotate your original in your scan, click one of the **Rotate** icons.

3. Click inside each scan area and make any necessary settings in the Epson Scan window.

Parent topic: [Scanning in Office Mode](#)

Available Image Adjustments - Office Mode

You can select these Image Adjustments options in Epson Scan Office Mode. Not all adjustment settings may be available, depending on other settings you have chosen.

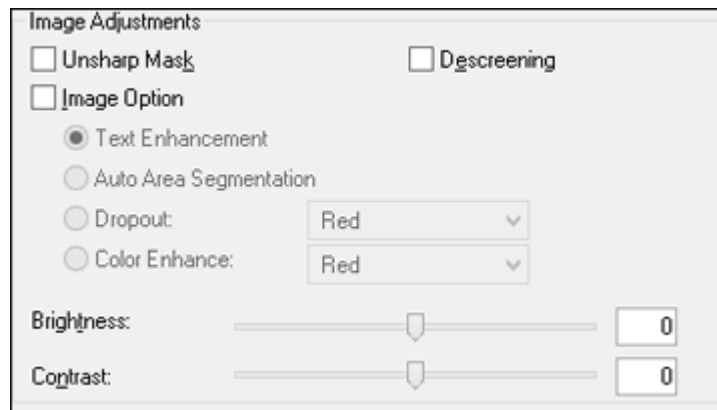

Note: Select the **Image Option** checkbox if you need to set any of the grayed-out image adjustments beneath the checkbox. Not all adjustment settings may be available, depending on the Image Type setting.

Unsharp Mask

Makes the edges of certain image areas clearer. Turn off this option to leave softer edges.

Descreening

Removes the ripple pattern that might appear in subtly shaded image areas, such as skin tones. This option improves results when scanning magazines or newspapers. (The results of descreening do not appear in the preview image, only in your scanned image.)

Text Enhancement

Sharpens the appearance of letters in text documents.

Auto Area Segmentation

Makes grayscale images clearer and text recognition more accurate by separating the text from the graphics.

Dropout

The scan will not pick up the color you select. This setting is only available if you select an Image Type of Grayscale or Black & White.

Color Enhance

Enhances the red, green, or blue shades in the scanned image.

Brightness

Adjusts the overall lightness and darkness of the scanned image.

Contrast

Adjusts the difference between the light and dark areas of the overall scanned image.

Threshold

Adjusts the level at which black areas in text and line art are delineated, improving text recognition in OCR (Optical Character Recognition) programs.

Parent topic: [Scanning in Office Mode](#)

Scanning in Professional Mode

When you scan in Professional Mode, Epson Scan automatically saves your scanned file in JPEG format in your operating system's Pictures or My Pictures folder, or opens it in your scanning program. You can select settings, preview, and change the scanned file settings as necessary.

1. Start Epson Scan and select **Professional Mode** as the Mode setting.

You see this window:

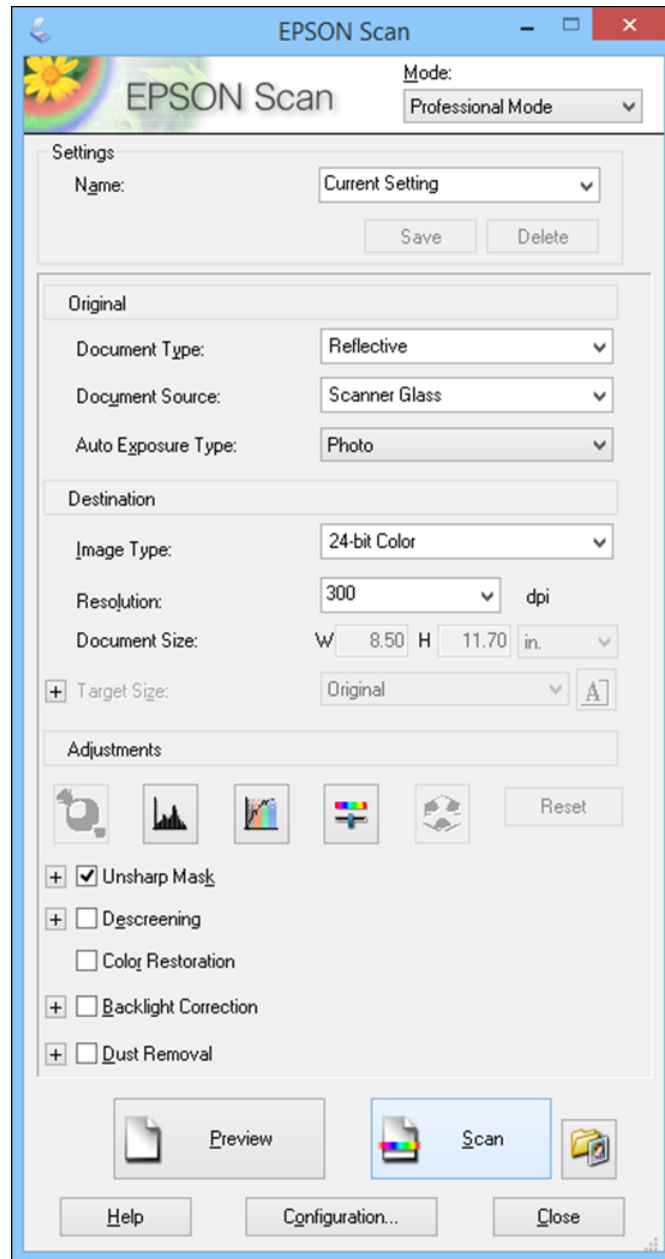

2. Select the **Document Type** setting that matches your original, such as **Reflective** for documents or photos.
3. Select the **Document Source** setting indicating where you placed your original.
4. Select the specific type of original you are scanning as the **Auto Exposure Type** setting: **Document** or **Photo**.
5. Select the details of your original and how you want it scanned as the **Image Type** setting.
6. Select the **Resolution** setting you want to use for your scan.
7. Click the **Preview** button.

Epson Scan previews your original and displays the result in a separate Preview window.

8. If desired, select the area in your preview image that you want to scan (scan area).
9. Select any of the image adjustment settings you want to use. Before making adjustments, click the image or scan area in the Preview window.
10. If you want to reduce or enlarge your image as you scan, select the **Target Size** setting you want to use.
11. Click **Scan**.

You see the File Save Settings window.

12. Change any of the necessary file save settings and click **OK**.

Epson Scan scans your original, and saves the file in the selected folder or opens it in your scanning program. If the file was saved directly to your computer, you see the file in the Windows Explorer or Mac Finder, where you can view and print the image, if desired.

[Available Image Types - Professional Mode](#)

[Available Image Adjustments - Professional Mode](#)

[Selecting a Scan Size - Professional Mode](#)

Parent topic: [Selecting Epson Scan Settings](#)

Related concepts

[Scan Resolution Guidelines](#)

Related tasks

[Selecting Scan File Settings](#)

Available Image Types - Professional Mode

You can select these Image Type options in Epson Scan Professional Mode.

24-bit Color

Select this setting for color photos.

Color Smoothing

Select this setting for color graphic images, such as charts or graphs.

8-bit Grayscale

Select this setting for black-and-white photos with a few shades of gray.

Black & White

Select this setting for black text documents or line art.

Parent topic: [Scanning in Professional Mode](#)

Available Image Adjustments - Professional Mode

You can select these Adjustments options in Epson Scan Professional Mode. Not all adjustment settings may be available, depending on other settings you have chosen.

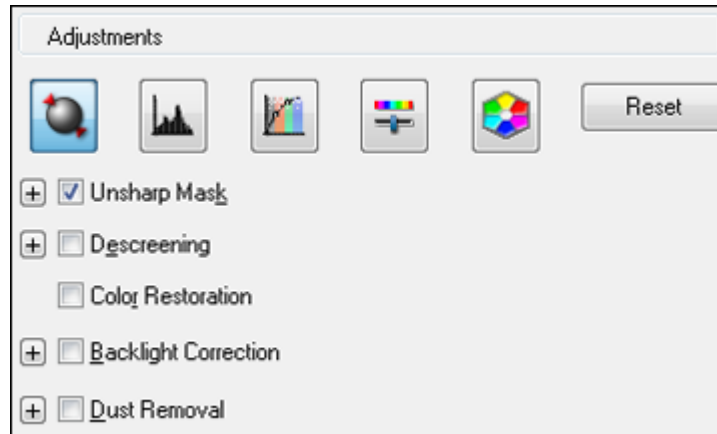

Click the  image adjustment icon to access additional settings.

Click the + (Windows) or ► (Mac) icon next to a setting to change the level of adjustment.

Unsharp Mask

Makes the edges of certain image areas clearer. Turn off this option to leave softer edges.

Descreening

Removes the ripple pattern that might appear in subtly shaded image areas, such as skin tones. This option improves results when scanning magazines or newspapers. (The results of descreening do not appear in the preview image, only in your scanned image.)

Color Restoration

Restores the colors in faded photos automatically.

Backlight Correction

Removes shadows from photos that have too much background light.

Dust Removal

Removes dust marks from your originals automatically.

Dropout

The scan will not pick up the color you select. This setting is only available if you select an Image Type of Grayscale or Black & White.

Color Enhance

Enhances the red, green, or blue shades in the scanned image.

Auto Exposure

Automatically adjusts the image exposure settings when you click the  Auto Exposure icon. To automatically adjust image exposure settings continuously, click the **Configuration** button, click the **Color** tab, and select **Continuous auto exposure**. You can adjust the level of auto exposure using a slider.

Histogram Adjustment

Provides a graphical interface for adjusting highlight, shadow, and gamma levels individually. (For advanced users only.) Click the  histogram icon to access the settings.

Tone Correction

Provides a graphical interface for adjusting tone levels individually. (For advanced users only.) Click the  tone correction icon to access the settings.

Brightness

Adjusts the overall lightness and darkness of the scanned image.

Contrast

Adjusts the difference between the light and dark areas of the overall scanned image.

Saturation

Adjusts the density of colors in the overall image.

Color Balance

Adjusts the balance of colors in the overall image.

Color Palette

Provides a graphical interface for adjusting mid-tone levels, such as skin tones, without affecting the highlight and shadow areas of the image. (For advanced users only.) Click the  Color Palette icon to access the settings.

Threshold

Adjusts the level at which black areas in text and line art are delineated, improving text recognition in OCR (Optical Character Recognition) programs.

Parent topic: [Scanning in Professional Mode](#)

Selecting a Scan Size - Professional Mode

You can reduce or enlarge the size of your image as you scan. You can also select a specific scan size, such as a common photo size like 4 × 6 inches (102 × 152 mm). This places a scan area of that size on the preview image so you can use it to help crop the image in the correct proportions.

1. Click the **Preview** button to preview your image.
2. In the Epson Scan window, select the size you want your scanned image to be from the **Target Size** list.



Note: If you need to rotate the orientation of the target size for your image, click the  orientation icon.

A marquee (dotted line) appears on your preview image proportioned for the size you selected.

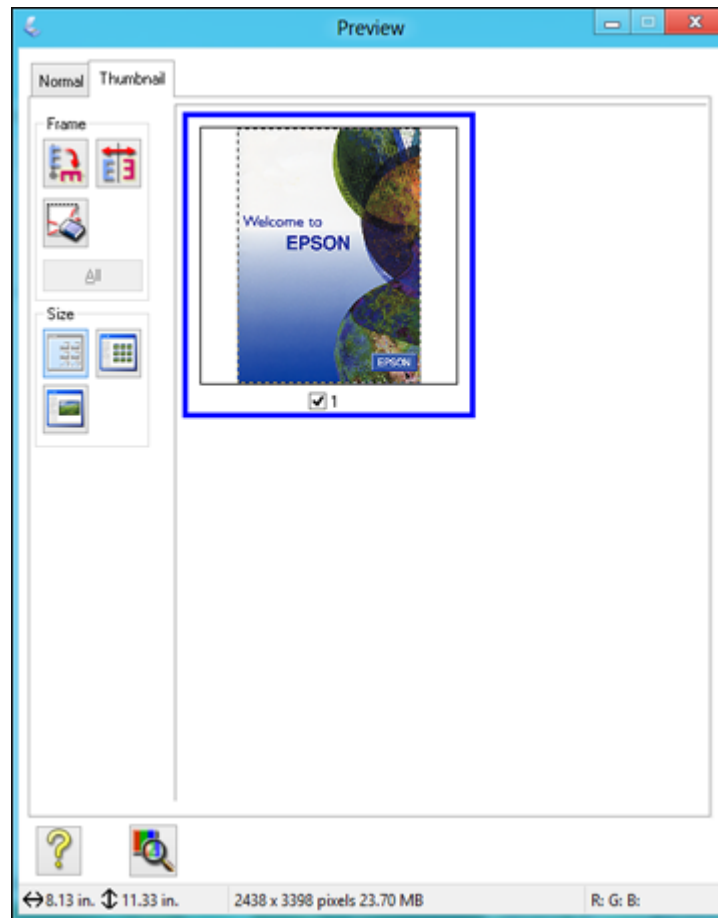

3. Do the following, as necessary, to work with the selected scan area:
 - To move the marquee, click inside the scan area and drag the marquee where you want it.
 - To resize the scan area, place your cursor over the edge or corner of the marquee, then click and drag the edge where you want it.

Note: Manually adjusting the marquee will not change the target size of the scanned file. The marquee only indicates the area of the image that will be scanned.

4. To create a scanned image size that is not available in the Target Size list, click the **Customize** option.

You see this window:

The screenshot shows a dialog box titled "Target Size" with a close button in the top right corner. On the left side, there is a label "Target Size:" above a large empty rectangular preview area. Below the preview are two buttons: "Save" and "Delete". On the right side, there is a label "Target Size Name:" above a text input field containing "User Defined". Below this are three more input fields: "Width:" (empty), "Height:" (empty), and "Units:" (a dropdown menu showing "in."). At the bottom of the dialog are two buttons: "OK" and "Cancel".

5. Name the custom size, enter the size, click **Save**, and click **OK**. Then adjust the marquee on the preview image.

The marquee is automatically proportioned for your custom scan size.

6. To use additional sizing tools, click the + (Windows) or ► (Mac) icon next to the Target Size setting and select options as desired.

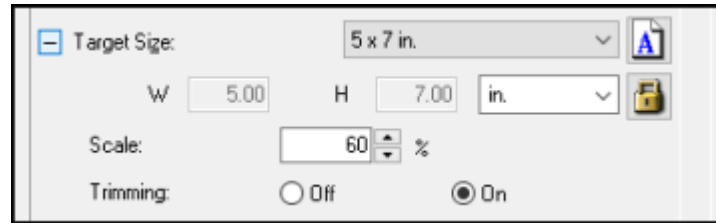

- **Scale:** Reduces or enlarges your image by the percentage you enter.
- **Trimming:** Turns automatic image cropping on or off.
-  **Unlock icon:** Unlocks the width/height proportions of the scanned image size so you can adjust it without constraint.

Parent topic: [Scanning in Professional Mode](#)

Image Preview Guidelines

You can preview your scanned image so you can adjust the scan settings using the preview as a guide. There are two types of preview available, depending on the scan mode and selected settings:

Thumbnail preview

A thumbnail preview displays your previewed images as thumbnails with the scanned image area and exposure automatically selected.

Normal preview

A normal preview displays your previewed images in their entirety so you can select the scanned image area and other settings manually.

Parent topic: [Selecting Epson Scan Settings](#)

Scan Resolution Guidelines

If you plan to enlarge a scanned image so you can print it at a larger size, you may need to increase the resolution from the default resolution set by Epson Scan. Follow these guidelines to determine the resolution setting you need:

- You will enlarge the image as you scan it.

If you will enlarge the image using Epson Scan's Target Size setting, you do not need to increase the Resolution setting.

- You will scan the image at its original size but enlarge it later in an image-editing program.

Increase Epson Scan's Resolution setting in your scan. Increase the resolution by the same amount you will increase the image size to retain a high image quality. For example, if the resolution is 300 dpi (dots per inch) and you will double the image size later, change the Resolution setting to 600 dpi.

- You will scan the image at 100% or smaller size.

Select Epson Scan's Resolution setting based on how you will use the scanned image:

- Email/view on a computer screen/post on the web: 96 to 150 dpi
- Print/convert to editable text (OCR): 300 dpi
- Fax: 200 dpi

Parent topic: [Selecting Epson Scan Settings](#)

Related topics

[Selecting Epson Scan Settings](#)

Selecting Scan File Settings

You can select the location, name, and format of your scan file on the File Save Settings window. You can also select various optional settings that control how Epson Scan behaves when you scan and save files.

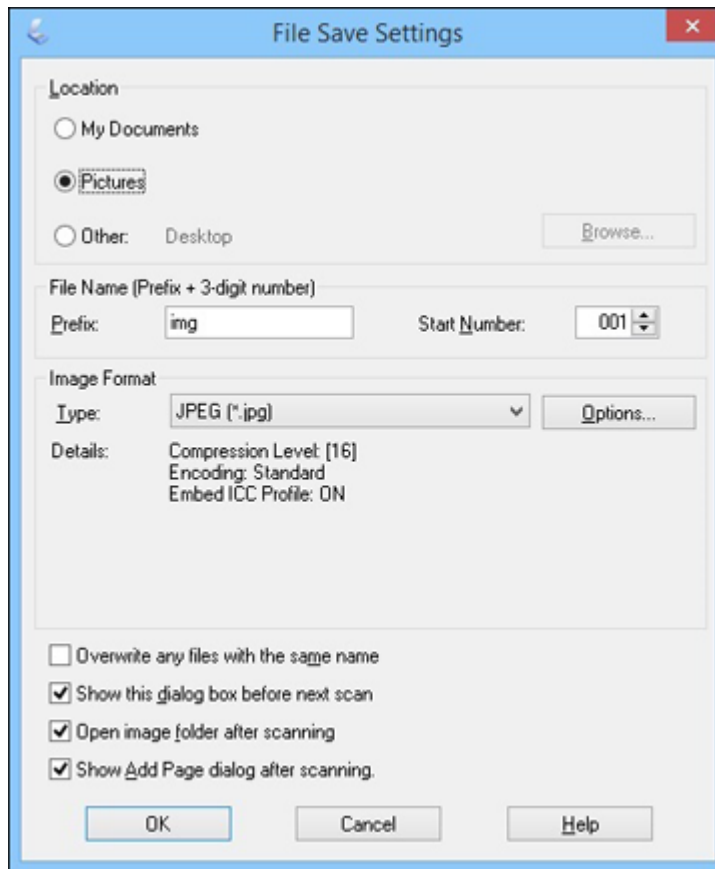

The File Save Settings window may appear after you click **Scan** on the Epson Scan window. You may also be able to access the window by clicking the  icon on the Epson Scan window.

1. Do one of the following to select the folder in which you want to save your scanned image:
 - Click the button for one of the displayed folders.

- Click the **Other** button, click the **Browse** or **Choose** button, and select a folder.
- 2. Type in a file name in the **Prefix** field. This name is used along with numbers to automatically name your scanned files.
- 3. Select a different number as the **Start Number** setting, if you like.
- 4. Select the file format you want to use in the Image Format **Type** menu.
- 5. If your file format provides optional settings, click the **Options** button to select them.
- 6. Choose any of the optional settings you want to use by selecting their checkboxes.
- 7. Click **OK**.

[Available Scanned File Types and Optional Settings](#)

Parent topic: [Selecting Epson Scan Settings](#)

Available Scanned File Types and Optional Settings

You can select from a variety of scanned file types and optional settings on the File Save Settings window in Epson Scan.

File Formats

Bitmap (*.bmp)

A standard image file format for most Windows programs.

JPEG (*.jpg)

An image format that lets you highly compress image data. However, the higher the compression, the lower the image quality. (The TIFF format is recommended when you need to modify or retouch your scanned image.)

Multi-TIFF (*.tif)

A TIFF file format when multiple pages are saved to the same file, allowing you to edit the images using a compatible program.

PDF (*.pdf)

A document format that is readable by Windows and Mac systems using Adobe Reader, Acrobat, or other programs. You can save multi-page documents in one PDF file.

PICT (*.pct)

A standard image file format for most Mac programs.

PRINT Image Matching II (*.jpg or *.tif)

File formats that include Epson PRINT Image Matching II data for enhanced quality and a wider color range (does not affect the way the image displays on the screen).

TIFF (*.tif)

A file format created for exchanging data between many programs, such as graphic and DTP software.

Optional Settings**Overwrite any files with the same name**

Select to overwrite previous files with the same names.

Show this dialog box before next scan

Select to have the File Save Settings window appear automatically before you scan (in certain Epson Scan modes).

Open image folder after scanning

Select to have Windows Explorer or Mac Finder automatically open to the folder where your scanned image is saved after scanning.

Show Add Page dialog after scanning

If you are scanning a multi-page document using the PDF or Multi-TIFF format, select to display a prompt for scanning additional pages after the first page is scanned.

Parent topic: [Selecting Scan File Settings](#)

Scanning Special Projects

Your product's scanning software offers various options to help you quickly complete special scan projects.

[Scanning to Online Destinations Using Easy Photo Scan](#)

[Restoring Photo Colors as You Scan](#)

[Scanning to a SharePoint Server or Cloud Service](#)

[Scanning Multi-Page Originals as Separate Files - Windows](#)

[Stitching Two Images in Epson ScanSmart](#)

[Scanning to a PDF File Using a Scanner Button](#)

[Using the Scanner as a Copier - Copy Utility](#)

Parent topic: [Scanning](#)

Scanning to Online Destinations Using Easy Photo Scan

You can scan documents or photos and upload them to online destinations, such as photo-sharing sites, web servers, or network folders using Easy Photo Scan.

Note: If you are using your Epson product with the Windows 10 S operating system, you cannot use the software described in this section. You also cannot download and install any Epson product software from the Epson website for use with Windows 10 S; you must obtain software only from the Windows Store.

[Scanning Using Easy Photo Scan](#)

[Uploading Scanned Images to Facebook](#)

[Uploading Scanned Images to Google Photos](#)

[Uploading Scanned Images to Evernote](#)

[Uploading Scanned Images to SugarSync](#)

[Uploading Scanned Images to a Web Folder](#)

[Uploading Scanned Images to Email](#)

[Saving Scanned Images to a Folder](#)



[Epson JPEG File Settings](#)

[Epson TIFF and Multi-TIFF File Settings](#)

Parent topic: [Scanning Special Projects](#)

Scanning Using Easy Photo Scan



You can use Easy Photo Scan to easily scan your originals, edit the scanned images, and upload them to online destinations.

1. Place your original on your product for scanning.
2. Do one of the following to open Easy Photo Scan:
 - **Windows 10:** Click  and select **Epson Software > Easy Photo Scan**. Select your product and click **OK**, if necessary.
 - **Windows 8.x:** Navigate to the **Apps** screen and select **Easy Photo Scan**. Select your product and click **OK**, if necessary.
 - **Windows (other versions):** Click  or **Start**, and select **All Programs** or **Programs**. Select **Epson Software > Easy Photo Scan**. Select your product and click **OK**, if necessary.
 - **Mac:** Open the **Applications** folder, select **Epson Software**, and select **Easy Photo Scan**. Select your product and click **OK**, if necessary.
 - Press the  send button on the scanner.

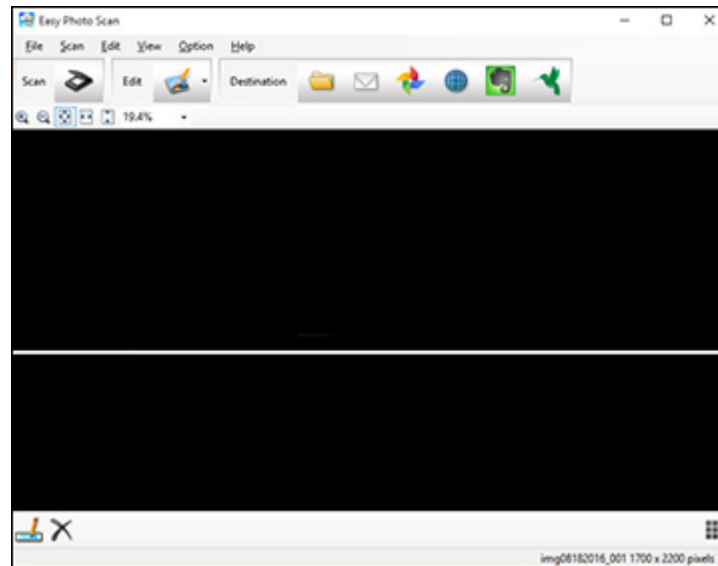
You see a window like this:



3. Click the  Scan icon.
Your scanning program launches.
4. Click **Scan** in the window that appears to scan your original.
The scanned image is displayed in the Easy Photo Scan window with an automatically generated name.

Note: You may need to close the scanning program window to display Easy Photo Scan.
5. To edit the name of the file, select the image thumbnail at the bottom of the screen, click the  icon, and enter the new filename.
6. To edit the scanned image, click the  Edit icon and select one of the displayed options.

Note: See the Easy Photo Scan help for additional information on image editing options.
7. Repeat these steps for each image you want to upload.

8. When you finish scanning, click one of the destination icons to upload the images.

Note: You may need to click the arrow next to the icons in order to see all of them. The available icons may vary, depending on the software version you are using.

Parent topic: [Scanning to Online Destinations Using Easy Photo Scan](#)

Related tasks

[Uploading Scanned Images to Facebook](#)

[Uploading Scanned Images to Google Photos](#)

[Uploading Scanned Images to Evernote](#)

[Uploading Scanned Images to SugarSync](#)

[Uploading Scanned Images to a Web Folder](#)

[Uploading Scanned Images to Email](#)

[Saving Scanned Images to a Folder](#)

Uploading Scanned Images to Facebook

You can configure a Facebook account for use with Easy Photo Scan and upload your scanned images to it.

1. Scan your original using Easy Photo Scan.
2. Click the  icon.

You see a window like this:

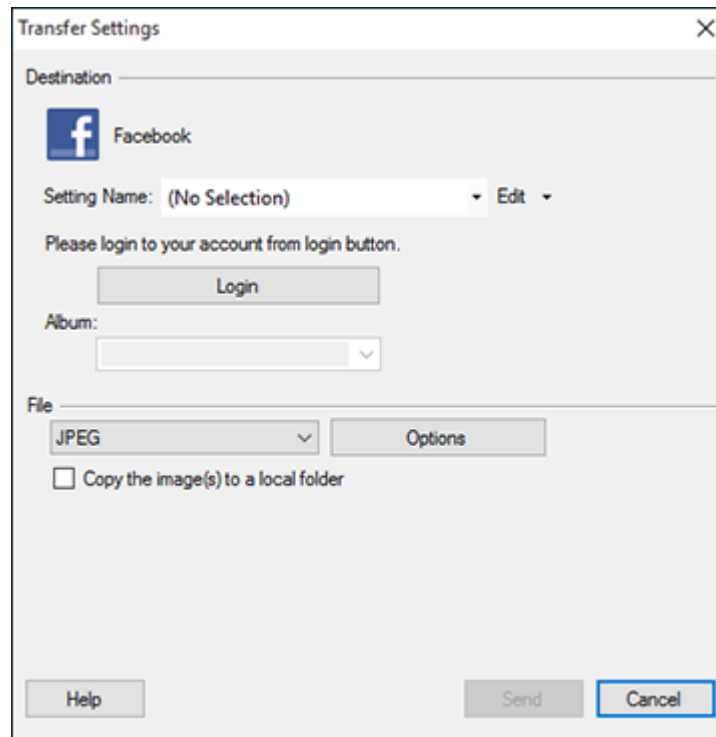

Note: If you have already configured a Facebook account in Easy Photo Scan, you can select the **Setting Name** or **Destination Name** for the account, click **Login** if necessary, and click **Send** to upload your images.

3. Click **Login**.
4. On the Application Authentication screen, log in to your Facebook account.

Note: To enable automatic image uploading, select the option for staying logged in.

5. Select an album from the **Album** list.

Note: If you cannot select an album, make sure the Setting Name is set to **(No Selection)**, click **Login** to log in to your Facebook account, and try again. If you want to create a new album, you must create it directly in Facebook.

6. Select the image format for the uploaded files from the **File** or **File Type** list.
7. If there are options for the selected file format, click **Options** or **Option** and select the options you want.
8. If you also want to save the images to a local folder, select the **Copy the image(s) to a local folder** checkbox and select a folder.
9. If you want to save the current settings, click **Edit**, or the **Setting Name** or **Destination Name** field, and select **Save As**. Enter a name for the setting and click **OK**.
10. Click **Send** to upload the images to your Facebook account, or click **Cancel** to cancel the operation.

Parent topic: [Scanning to Online Destinations Using Easy Photo Scan](#)

Related references

[Epson JPEG File Settings](#)

Related tasks

[Scanning Using Easy Photo Scan](#)

Uploading Scanned Images to Google Photos

You can configure a Google Photos account for use with Easy Photo Scan and upload your scanned images.

1. Scan your original using Easy Photo Scan.

2. Click the  icon.

You see a window like this:

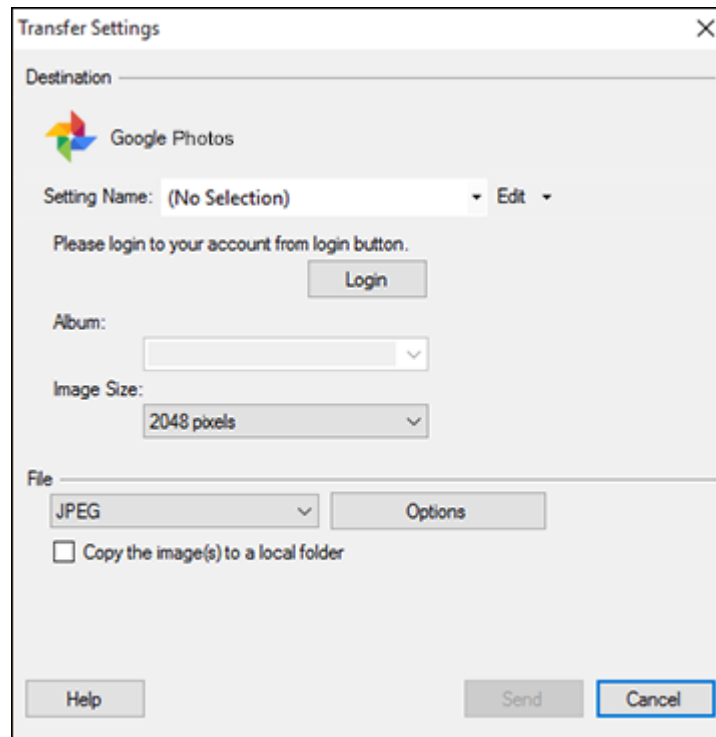

Note: If you have already configured a Google Photos account in Easy Photo Scan, you can select the **Setting Name** or **Destination Name** for the account, click **Login** if necessary, and click **Send** to upload your images.

3. Click **Login**.
4. On the Application Authentication screen, log into your Google account.
5. Click **Accept** to allow Easy Photo Scan to upload images to your account.
An authentication code is generated.
6. Copy the authentication code into the **Please enter authentication code** field and click **OK**.

7. Select an album from the **Album** list.

Note: If you cannot select an album, make sure the Setting Name is set to **(No Selection)**, click the **Login** button to log into your Google Photos account, and try again. If you want to create a new album, you must create it directly in Google Photos.

8. Select an **Image Size** option for the uploaded images.
9. Select the image format for the uploaded files from the **File** or **File Type** list.
10. If there are options for the selected file format, click **Options** or **Option** and select the options you want.
11. If you also want to save the images to a local folder, select the **Copy the image(s) to a local folder** checkbox and select a folder.
12. If you want to save the current settings, click **Edit**, or the **Setting Name** or **Destination Name** field, and select **Save As**. Enter a name for the setting and click **OK**.
13. Click **Send** to upload the images to your Google Photos account, or click **Cancel** to cancel the operation.

Parent topic: [Scanning to Online Destinations Using Easy Photo Scan](#)

Related references

[Epson JPEG File Settings](#)

Related tasks

[Scanning Using Easy Photo Scan](#)

Uploading Scanned Images to Evernote

You can configure an Evernote account for use with Easy Photo Scan and upload your scanned images to it (Windows only).

Note: You must install Evernote before you can use it with Easy Photo Scan.

1. Scan your original using Easy Photo Scan.
2. Click the  icon.

You see a window like this:

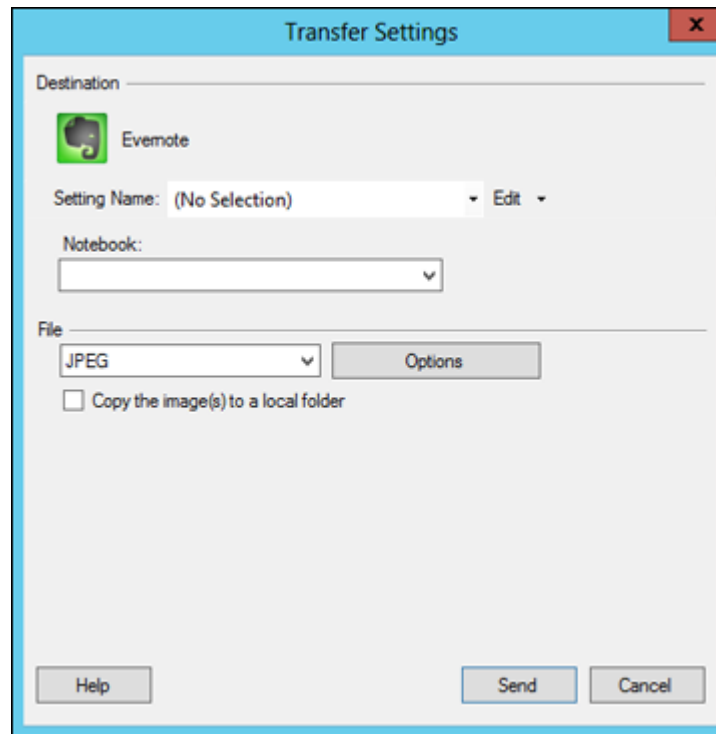

Note: If you have already configured an Evernote account in Easy Photo Scan, you can select the **Setting Name** or **Destination Name** for the account and click **Send** to upload your images.

3. Select a notebook from the **Notebook** list.

Note: If you want to create a new notebook, you must create it directly in Evernote.

4. Select the image format for the uploaded files from the **File** or **File Type** list.
5. If there are options for the selected file format, click **Options** or **Option** and select the options you want.
6. If you also want to save the images to a local folder, select the **Copy the image(s) to a local folder** checkbox and select a folder.

7. If you want to save the current settings, click **Edit**, or the **Setting Name** or **Destination Name** field, and select **Save As**. Enter a name for the setting and click **OK**.
8. Click **Send** to upload the images to your Evernote account, or click **Cancel** to cancel the operation.

Parent topic: [Scanning to Online Destinations Using Easy Photo Scan](#)

Related references

[Epson JPEG File Settings](#)

Related tasks

[Scanning Using Easy Photo Scan](#)

Uploading Scanned Images to SugarSync

You can configure a SugarSync account for use with Easy Photo Scan and upload your scanned images.

1. Scan your original using Easy Photo Scan.
2. Click the  icon.

You see a window like this:

The screenshot shows a 'Transfer Settings' dialog box. It features a blue title bar with the text 'Transfer Settings' and a close button (X). The main content area is light gray and contains several sections: 'Destination' with the SugarSync logo and a 'Setting Name' dropdown menu (currently showing '(No Selection)') with an 'Edit' button; 'E-Mail Address' and 'Password' text input fields; 'Place' dropdown menu (currently showing 'Magic Briefcase') and 'Folder' text input field; an unchecked checkbox labeled 'Overwrite file(s) with the same name'; a 'Check Connection' button; 'File' section with a format dropdown menu (currently showing 'JPEG') and an 'Options' button; and an unchecked checkbox labeled 'Copy the image(s) to a local folder'. At the bottom of the dialog are three buttons: 'Help', 'Send', and 'Cancel'.

Note: If you have already configured a SugarSync account in Easy Photo Scan, you can select the **Setting Name** or **Destination Name** for the account and click **Send** to upload your images.

3. Enter the account information in the **E-Mail Address** and **Password** fields.
4. Select a **Place** option for the uploaded images.

Note: In SugarSync, the Magic Briefcase is now called "My SugarSync". Uploads to the Magic Briefcase appear in the My SugarSync folder.

5. Enter a folder name in the **Folder** field.

If you enter the name of an existing folder, the images are uploaded to that folder. If the folder does not exist, a new folder with that name is created.

6. If you want to replace existing files with the same name with the uploaded images, click the **Overwrite file(s) with the same name** checkbox.
7. Click **Check Connection** to test whether the SugarSync account information is correct.
8. Select the image format for the uploaded files from the **File** or **File Type** list.
9. If there are options for the selected file format, click **Options** or **Option** and select the options you want.
10. If you also want to save the images to a local folder, select the **Copy the image(s) to a local folder** checkbox and select a folder.
11. If you want to save the current settings, click **Edit**, or the **Setting Name** or **Destination Name** field, and select **Save As**. Enter a name for the setting and click **OK**.
12. Click **Send** to upload the images to your SugarSync account, or click **Cancel** to cancel the operation.

Parent topic: [Scanning to Online Destinations Using Easy Photo Scan](#)

Related references

[Epson JPEG File Settings](#)

[Epson TIFF and Multi-TIFF File Settings](#)

Related tasks

[Scanning Using Easy Photo Scan](#)

Uploading Scanned Images to a Web Folder

You can upload your scanned images to a Web Folder (WebDAV) using Easy Photo Scan.

1. Scan your original using Easy Photo Scan.
2. Click the  icon.

You see a window like this:

Transfer Settings

Destination

Web Folder (WebDAV)

Setting Name: (No Selection) Edit

Address:
http://www.example.com/upload

User Name: Password:

Overwrite file(s) with the same name

Check Connection

File

JPEG Options

Copy the image(s) to a local folder

Help Send Cancel

Note: If you have already configured a Web Folder account in Easy Photo Scan, you can select the **Setting Name** or **Destination Name** for the account and click **Send** to upload your pictures.

3. Enter the Web Folder URL in the **Address** field.
4. Enter the login information in the **User Name** and **Password** fields.
5. If you want to replace existing files with the same name with the uploaded images, click the **Overwrite file(s) with the same name** checkbox.
6. Click **Check Connection** to test whether the account information is correct.
7. Select the image format for the uploaded files from the **File** or **File Type** list.
8. If there are options for the selected file format, click **Options** or **Option** and select the options you want.

9. If you also want to save the images to a local folder, select the **Copy the image(s) to a local folder** checkbox and select a folder.
10. If you want to save the current settings, click **Edit**, or the **Setting Name** or **Destination Name** field, and select **Save As**. Enter a name for the setting and click **OK**.
11. Click **Send** to upload the images to your Web Folder, or click **Cancel** to cancel the operation.

Parent topic: [Scanning to Online Destinations Using Easy Photo Scan](#)

Related references

[Epson JPEG File Settings](#)

[Epson TIFF and Multi-TIFF File Settings](#)

Related tasks

[Scanning Using Easy Photo Scan](#)

Uploading Scanned Images to Email

You can save your scanned images to a local network folder and send them by email using Easy Photo Scan.

Note: With Windows, Easy Photo Scan supports Microsoft Outlook 2000/2002/2003/2007/2010 (x86)/2013 (x86) and Windows Mail/Windows Live Mail. If you do not have one of these email applications, Easy Photo Scan saves the images, but the email application does not open.

1. Scan your original using Easy Photo Scan.
2. Click the  icon.

You see a window like this:

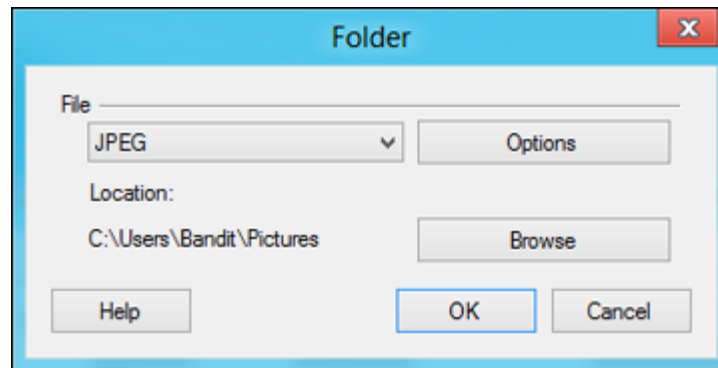

Note: On a Mac, you also enter an email address and email text in the window. If you have already configured email settings in Easy Photo Scan, you can select them using the **Destination Name** field.

3. Select the image format for the saved files from the **File** or **File Type** list.
4. If there are options for the selected file format, click **Options** or **Option** and select the options you want.
5. Do one of the following:
 - **Windows:** Click **Browse** to choose the folder where you want to save the images. Then click **OK** to save the images to the folder and launch your email program, or click **Cancel** to cancel the operation.
 - **Mac:** If you also want to save the images to a local folder, select the **Copy the image(s) to a local folder** checkbox and select a folder. Then click **Send**, or click **Cancel** to cancel the operation.

Parent topic: [Scanning to Online Destinations Using Easy Photo Scan](#)

Related references

[Epson JPEG File Settings](#)

[Epson TIFF and Multi-TIFF File Settings](#)

Related tasks

[Scanning Using Easy Photo Scan](#)

Saving Scanned Images to a Folder

You can save your scanned images to a local network folder using Easy Photo Scan.

1. Scan your original using Easy Photo Scan.
2. Click the  icon.

You see a window like this:

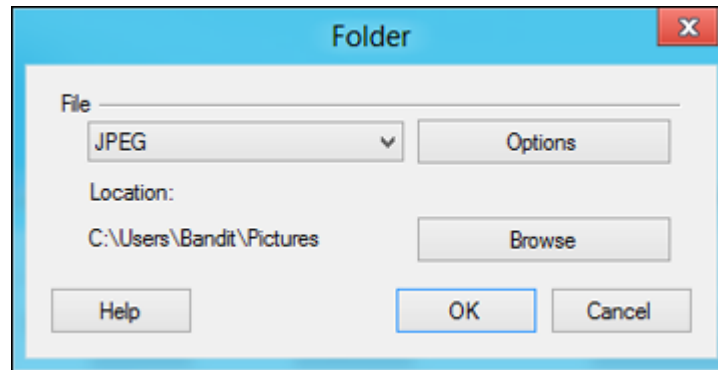

3. Select the image format for the saved files from the **File** or **File Type** list.
4. If there are options for the selected file format, click **Options** and select the options you want.

Note: See the help information in Easy Photo Scan for details on the file format options.

5. Click **Browse** or the **Save in** field to choose the folder where you want to save the images.
6. Click **OK** to save the images to the folder, or click **Cancel** to cancel the operation.

Parent topic: [Scanning to Online Destinations Using Easy Photo Scan](#)

Related references

[Epson JPEG File Settings](#)

[Epson TIFF and Multi-TIFF File Settings](#)

Related tasks

[Scanning Using Easy Photo Scan](#)

Epson JPEG File Settings

You can select from the following settings in the JPEG settings window in Easy Photo Scan.

Note: The available settings may vary, depending on the operating system you are using.

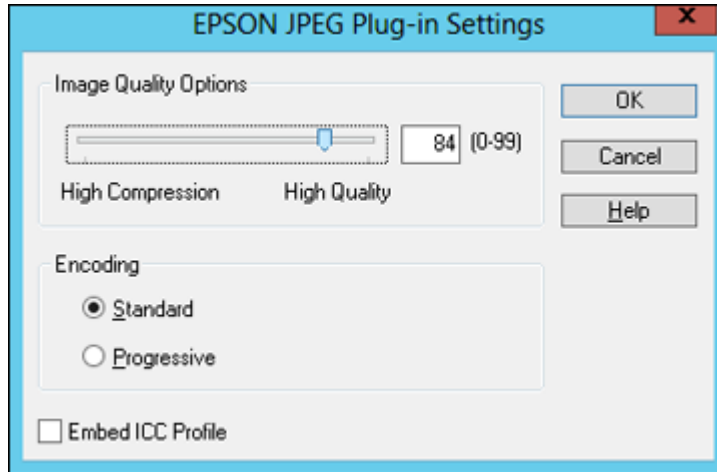

Setting	Description
Image Quality Options	Specifies the compression level. The file size increases with higher quality.
Encoding	Specifies the encoding method. Standard: Images are rendered from the top to the bottom when displayed on a web browser. Progressive: Images are rendered in low resolution in a web browser, then replaced with a higher resolution.
Embed ICC Profile	Allows the ICC profile (information on color reproducibility of scanned image) to be embedded in the image. Programs that use color management software will display the colors of the image using the ICC profile.

Parent topic: [Scanning to Online Destinations Using Easy Photo Scan](#)

Epson TIFF and Multi-TIFF File Settings

You can select from the following settings in the TIFF settings window in Easy Photo Scan.

Note: The available settings may vary, depending on the operating system you are using.

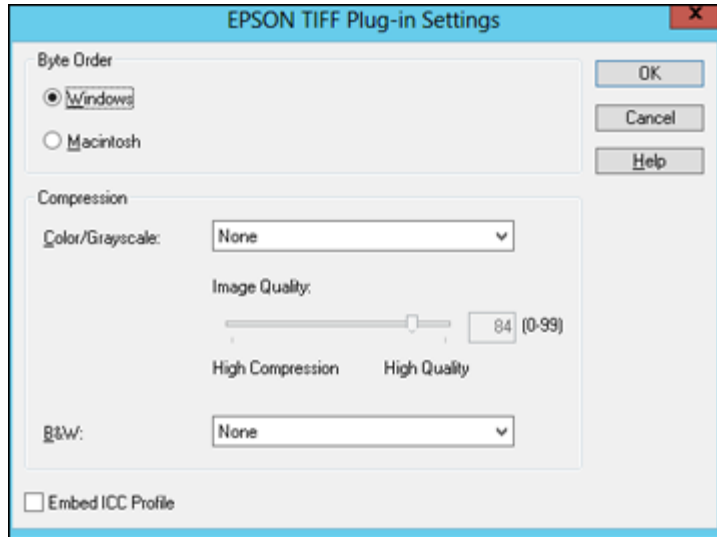

Setting	Description
Byte Order	Specifies the operating system where the scanned image will be used.
Compression	Specifies the compression format and level for Color/Grayscale and B&W images. The file size increases with higher quality.
Embed ICC Profile	Allows the ICC profile (information on color reproducibility of scanned image) to be embedded in the image. Programs that use color management software will display the colors of the image using the ICC profile.

Parent topic: [Scanning to Online Destinations Using Easy Photo Scan](#)

Restoring Photo Colors as You Scan

You can restore the colors in faded photos as you scan them using Epson Scan's Color Restoration setting. You can select this setting in any of the available scan modes.

Note: Color restoration is not available in Office Mode, if Epson Scan offers that mode.

1. Place your original on your product for scanning.
2. Start Epson Scan.
3. Select the scan mode you want to use.
4. Select the scan settings for your scan.
5. Preview your image.
6. Locate or access the image adjustment settings.
7. Select the **Color Restoration** checkbox.





8. When you finish selecting all your settings, click **Scan**.
9. Click **Close** to exit the Epson Scan window, if necessary.

Epson Scan scans your original, and saves the color-restored file in the selected folder or opens it in your scanning program. If the file was saved directly to your computer, you see the file in the Windows Explorer or Mac Finder, where you can view and print the image, if desired.

Parent topic: [Scanning Special Projects](#)

Scanning to a SharePoint Server or Cloud Service

You can use Document Capture Pro (Windows) or Document Capture (Mac) to upload scanned images to a SharePoint server or a cloud service.



1. Do one of the following to start Document Capture Pro (Windows) or Document Capture (Mac):
 - **Windows 10:** Click  and select **Epson Software > Document Capture Pro**.
 - **Windows 8.x:** Navigate to the **Apps** screen and select **Document Capture Pro**.
 - **Windows (other versions):** Click  or **Start**, and select **All Programs** or **Programs**. Select **Epson Software > Document Capture Pro**.
 - **Mac:** Open the **Applications** folder, open the **Epson Software** folder, and select **Document Capture**.

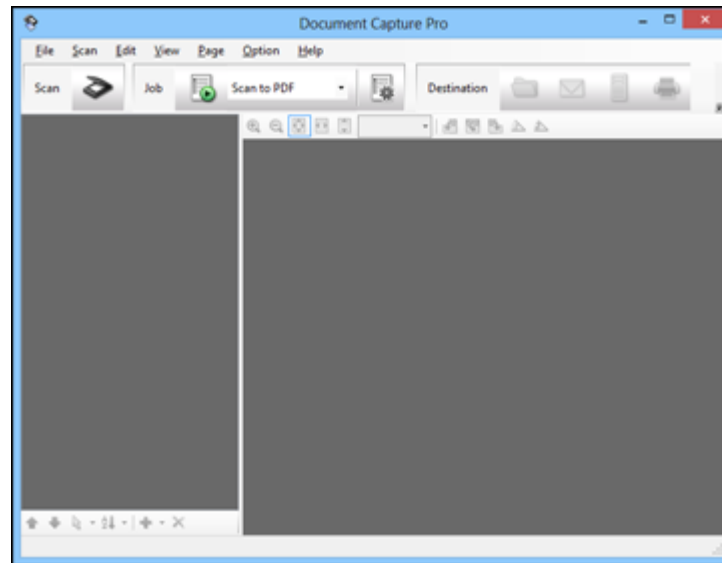

You see a window like this:



2. Click the  **Scan** icon.
3. Select any displayed scan settings you want to use.

Note: See the Help information in Document Capture Pro or Document Capture for details.

4. Click **Scan**.
You see a preview of your scan in the Document Capture Pro or Document Capture window.
5. Click one of the cloud service Destination icons to choose where to save your scanned file. (If you cannot see all of the icons below, the service software may not be installed, the service may not be available on your platform, or you need to click the arrow next to the icons.)
 -  Web Folder (WebDAV)
 -  Microsoft SharePoint server (Windows only)
 -  Evernote (Windows only)

-  Microsoft OneNote (Windows only)
-  Google Drive
-  SugarSync

You see the Transfer Settings window.

6. Enter any required information to set up the destination. If you have previously created a saved setting for the destination, select it from the drop-down list.
7. Adjust any save settings, then click **OK** or **Send**, depending on the destination.
Your originals are scanned and uploaded to the indicated server.

Parent topic: [Scanning Special Projects](#)

Scanning Multi-Page Originals as Separate Files - Windows

You can use Document Capture Pro (Windows only) to scan multi-page originals as separate scanned files. You indicate where you want the new scanned files to start by inserting a blank page or barcode between the pages of your original.

Note: The settings may vary, depending on the software version you are using. See the Help information in Document Capture Pro for details.

1. Load a multi-page original with blank pages or barcodes inserted where you want to start a new scanned file.
2. Do one of the following to start Document Capture Pro:
 - **Windows 8.x:** Navigate to the **Apps** screen and select **Document Capture Pro**.
 - **Windows (other versions):** Click  or **Start**, and select **All Programs** or **Programs**. Select **EPSON Software**, then select **Document Capture Pro**.

You see this window:

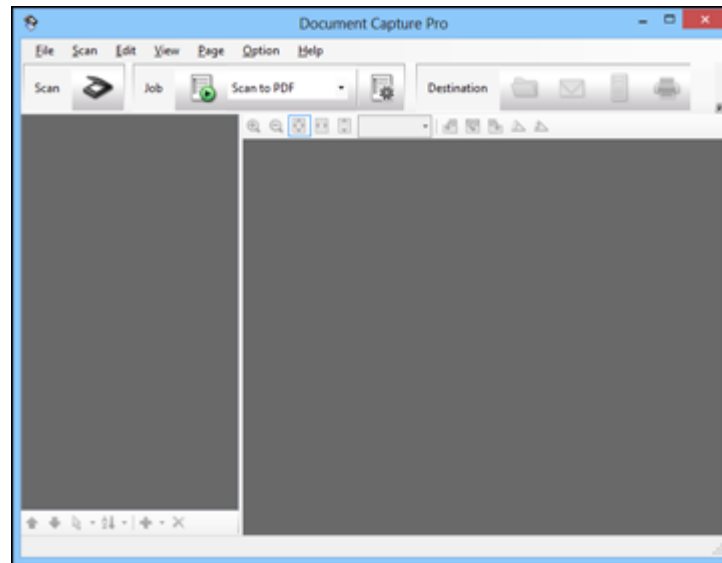

3. Click the  **Scan** icon.
4. Select any displayed scan settings you want to use.

Note: See the Help information in Document Capture Pro for details.

5. Click **Scan**.
You see a preview of your scan in the Document Capture Pro window.
6. Click one of the Destination icons to choose where to send your scanned files. (If you cannot see all of the icons below, click the arrow next to the icons.)



7. Click **File Name & Separation Settings**.
8. Select **Apply Job Separation** and click **Separation Settings**.

9. Select the method you used to separate the originals, select a folder name specification, and click **OK**.
10. Select any additional settings and click **OK** or **Send**.
Your originals are saved into separate files as specified.



Parent topic: [Scanning Special Projects](#)

Stitching Two Images in Epson ScanSmart

You can scan a double-sided or folded document and stitch the images together in Epson ScanSmart. (Perfection V39)

Note: The images in this guide show Windows screens. Mac screens may be slightly different.

Note: You can use Epson ScanSmart with the following operating system versions:

- Windows 7 or later
 - macOS 10.11.x to 10.15.x
1. Load your first original into the scanner.
 2. Open Epson ScanSmart on your computer. Do one of the following:
 - **Windows 10:** Click  > **Epson Software** > **Epson ScanSmart**.
 - **Windows 8.x:** Navigate to the **Apps** screen and select **Epson ScanSmart**.
 - **Windows (other versions):** Click  or **Start**, and select **All Programs** or **Programs**. Select **Epson Software** > **Epson ScanSmart**.
 - **Mac:** Open the **Applications** folder, open the **Epson Software** folder, and select **Epson ScanSmart**.

You see a screen like this:

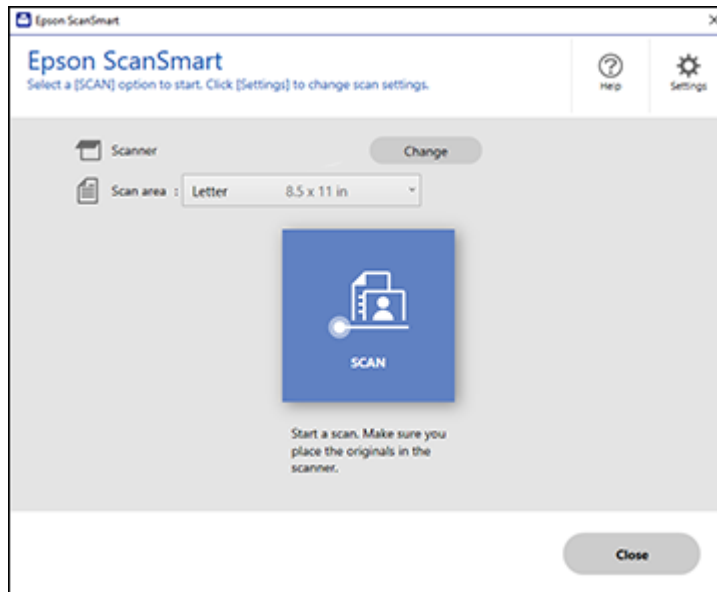

3. Select a scan option.

The scan job begins and your original is scanned. When scanning is complete, you see a screen like this:



4. Load the next page into the scanner and click **Scan**. Repeat until all originals are scanned.
5. Control-click the pages to be stitched and select **Stitch Images**.
6. Do one of the following:
 - Select **Basic Stitching** to stitch two pages together.
 - Select **Advanced Stitching** to stitch multiple overlapping images.
7. If you selected **Basic Stitching**, use the on-screen tools to change the position and orientation of the selected images, if necessary.

Note: You can switch the order of the images by clicking and dragging an image to the new position.

8. Select **OK** to create the combined image or **Cancel** to cancel the operation.

Note: The images you selected will be deleted and replaced with the combined image.

9. Select **Next** and select an option to save, send, or print the scanned images.

You see a screen like this:

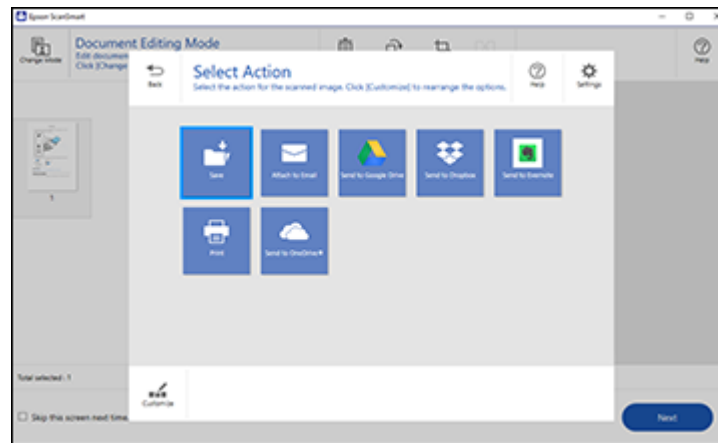

Note: The destinations shown may be different depending on your product or software version. For details on saving or uploading your images, select the **Help** icon.

10. Select an option to save, send, or print the scanned images.

Parent topic: [Scanning Special Projects](#)

Scanning to a PDF File Using a Scanner Button

You can scan to a PDF (Portable Document Format) file by pressing the  PDF button on your scanner.

You can select the following options as you scan to PDF:

- Scan multiple pages to one PDF file
 - Scan multiple pages to multiple PDF files
 - Create a searchable PDF file
1. Place your original on your product for scanning.
 2. Press the  PDF button on your scanner.

You see this window:

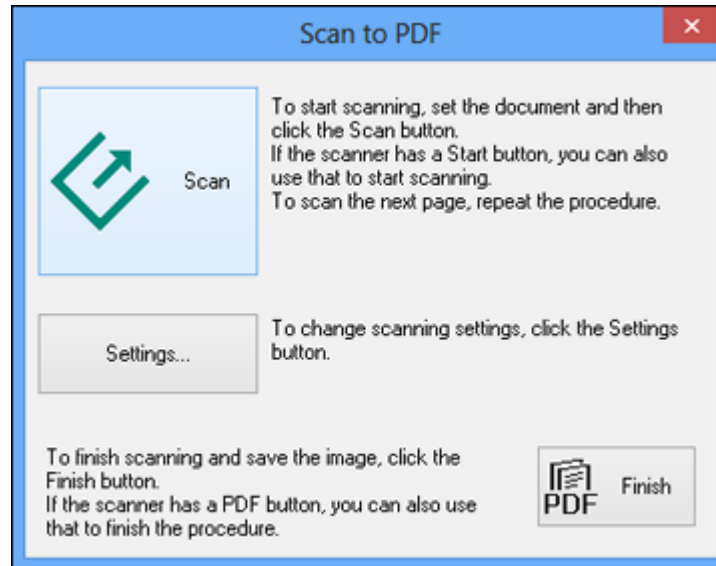

3. Click **Settings**.

You see this window:

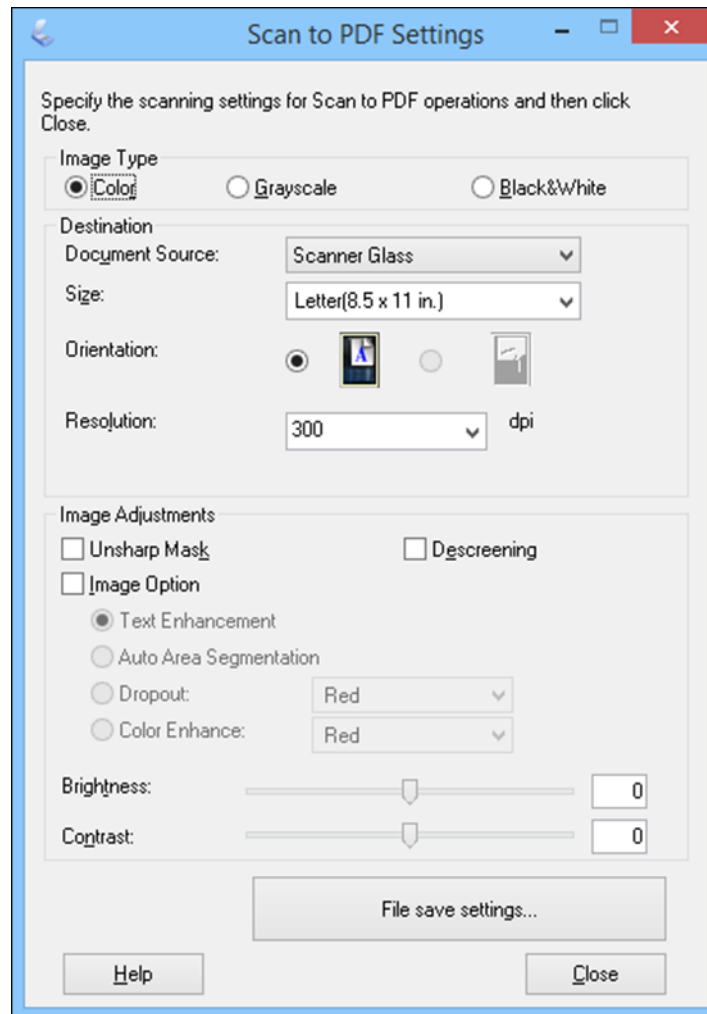

4. Select the **Image Type** setting for the type of original you are scanning.
5. Select the **Size**, **Orientation**, and **Resolution** settings for your scan.
6. Select any of the available Image Adjustments settings.
7. Click **File save settings**.

You see this window:

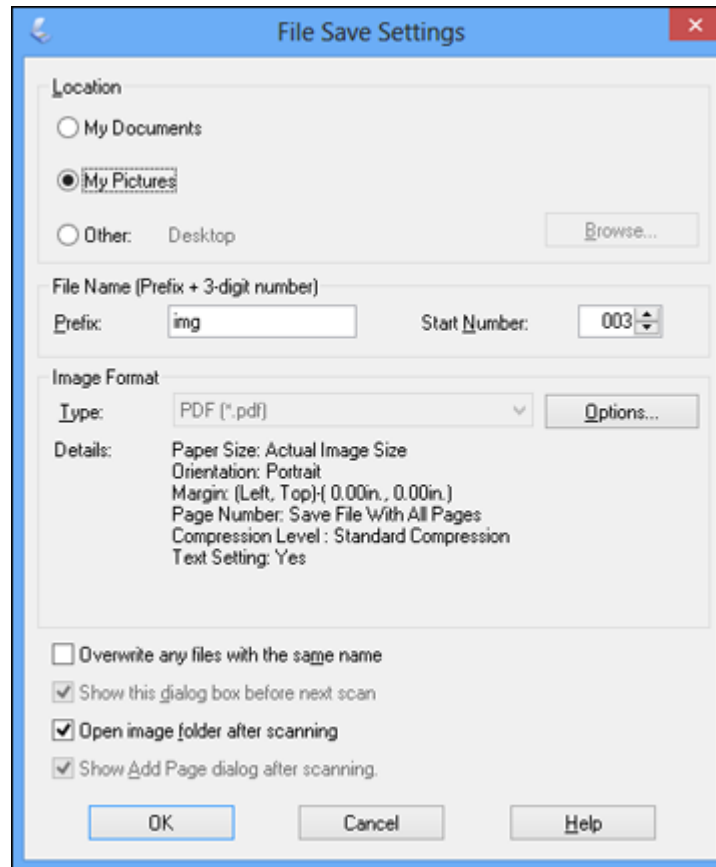

8. To change any of the displayed PDF Image Format settings, click the **Options** button.

You see this window:

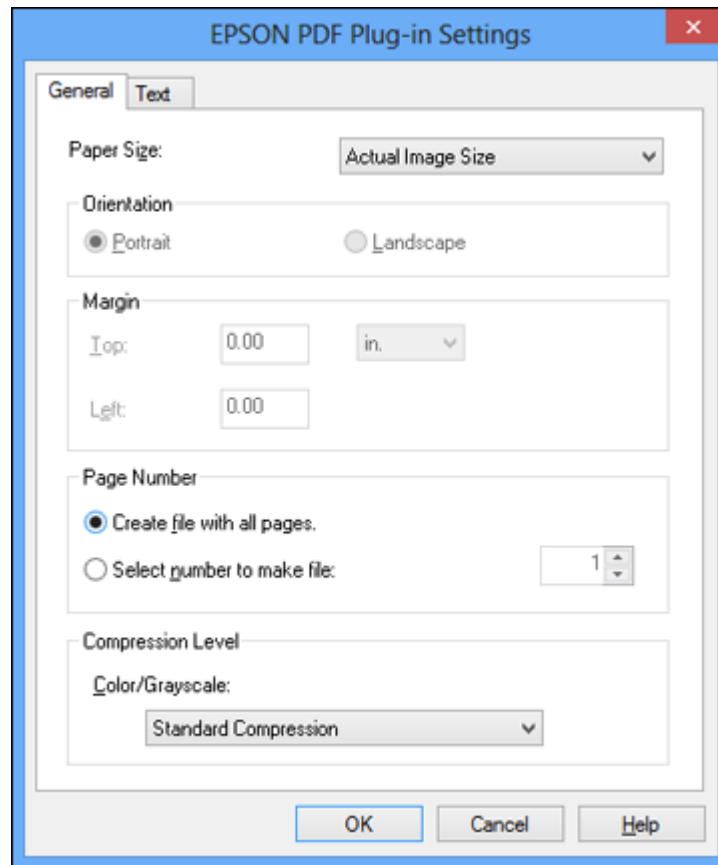

9. Select one of the following options on the General tab to indicate the number of PDF files you want to create:
 - To create one PDF file of all the scanned pages, select **Create file with all pages.**
 - To create multiple PDF files of groups of scanned pages, select **Select number to make file.** Enter the number of pages you want in each file in the number field. For example, with a 20-page original, enter **4** to create 5 PDF files of 4 pages each.

Note: To create a searchable PDF file, select the Text tab and select **Create searchable PDF**, then select the language of the original document.

10. Click **OK**.
11. Click **Close** to close the Scan to PDF Settings window.
12. Click the large **Scan** button.
Epson Scan scans your page.
13. Choose one of the following options on the screen:
 - If you are scanning only one page, click **Finish**.
 - If you need to scan additional pages in a document, place additional pages on the product for scanning, click **Scan**, and repeat until you have scanned all the pages. When you are finished, click **Finish**.

Epson Scan saves the files in the selected folder.

[Available Image Adjustments - Scan to PDF Settings](#)

Parent topic: [Scanning Special Projects](#)

Available Image Adjustments - Scan to PDF Settings

You can select these Adjustments options in the Scan to PDF Settings window.

Note: Not all adjustment settings may be available, depending on the Image Type setting.

Select the **Image Option** checkbox to access additional settings.

Unsharp Mask

Makes the edges of certain image areas clearer. Turn off this option to leave softer edges.

Descreening

Removes the ripple pattern that might appear in subtly shaded image areas, such as skin tones. This option improves results when scanning magazines or newspapers. (The results of descreening do not appear in the preview image, only in your scanned image.)

Brightness

Adjusts the overall lightness and darkness of the scanned image.

Contrast

Adjusts the difference between the light and dark areas of the overall scanned image.

Text Enhancement

Sharpens the appearance of letters in text documents.

Auto Area Segmentation

Makes grayscale images clearer and text recognition more accurate by separating the text from the graphics.

Dropout

The scan will not pick up the color you select. This setting is only available if you select an Image Type of Grayscale or Black & White.

Color Enhance

Enhances the red, green, or blue shades in the scanned image.



Threshold

Adjusts the level at which black areas in text and line art are delineated, improving text recognition in OCR (Optical Character Recognition) programs.

Parent topic: [Scanning to a PDF File Using a Scanner Button](#)

Using the Scanner as a Copier - Copy Utility

You can use your scanner along with a printer connected to your computer just like you would use a copy machine. Using the Copy Utility, you can enlarge or reduce, restore faded colors, and adjust a variety of other settings as you copy.

1. Do one of the following to start Copy Utility:
 - **Windows 8.x:** Navigate to the **Apps** screen and select **Copy Utility**.
 - **Windows (other versions):** Click  or **Start**, and select **All Programs** or **Programs**. Select **EPSON Software**, then select **Copy Utility**.
 - **Mac:** Open the **Applications** folder, select the **Epson Software** folder, and select **Copy Utility**.
 - Press the  copy button on the scanner.

You see a window like this:

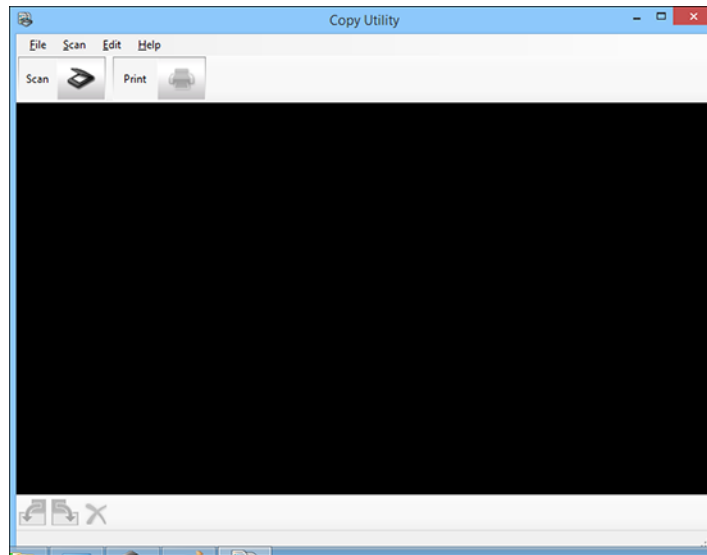

2. Click the  **Scan** icon.

You see a window like this:

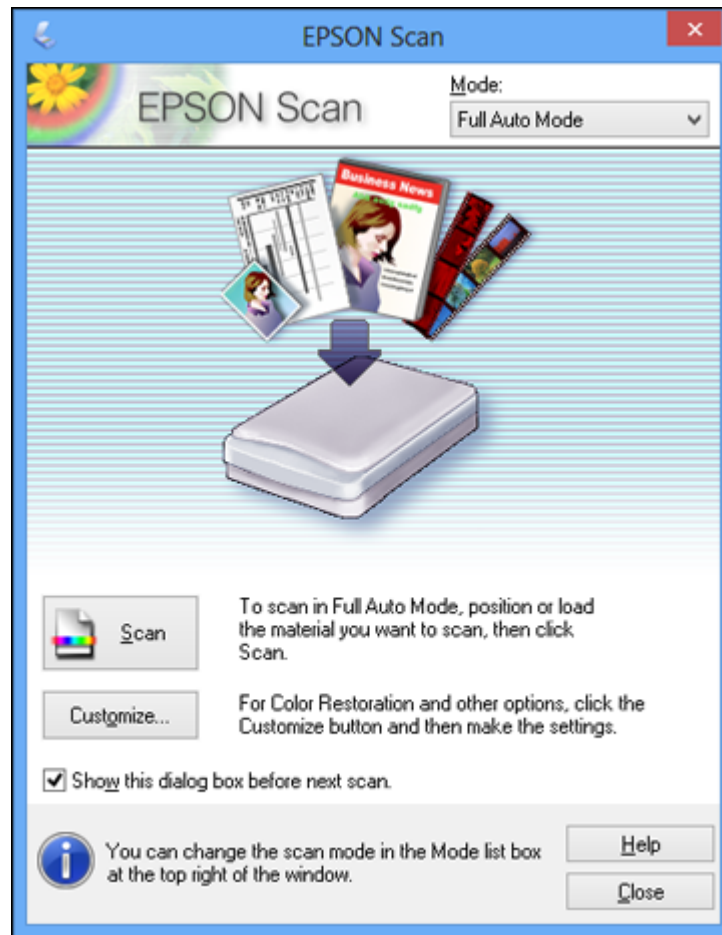

Note: If you started the scan from a scanner button, the Epson Scan window opens automatically. If you have previously used Epson Scan, it may start in a different mode.

3. Select any scan settings you want to use.

Note: See the Help information in Epson Scan for details.

4. Click **Scan**.

You see a thumbnail of your scan in the Copy Utility window. You may need to click **Close** on the Epson Scan window to display the thumbnail.

5. If you would like to scan additional originals and add them to the current captured images, click **Scan** again.
6. Rotate the images if necessary by selecting the thumbnail and clicking the rotate buttons at the bottom of the window.
7. Select the image(s) you want to print and click the **Print** button.
8. Choose a printer from the drop-down list and select settings. Click **Printer Settings** to select specific printer settings.

Note: See the Help information in Copy Utility for details.

9. Click **Print** to print your selected images.

Parent topic: [Scanning Special Projects](#)

Cleaning and Transporting Your Scanner

See these sections if you need to clean or transport your scanner.

[Cleaning Your Scanner](#)

[Transporting Your Scanner](#)

Cleaning Your Scanner

To keep your product working at its best, you should clean it several times a year.

Caution: Do not use a hard brush, alcohol, or paint thinner to clean the product or you may damage it. Do not use oil or other lubricants inside the product or let water get inside it. Do not open the product case. Do not press the surface of the scanner glass with any force and be careful not to scratch or damage the scanner glass. A damaged glass surface can decrease the scan quality.

1. Disconnect the USB cable.
2. Clean the outer case with a cloth dampened with mild detergent and water.
3. If the scanner glass gets dirty, clean it with a soft, dry cloth. If the glass surface is stained with grease or some other hard-to-remove material, use a small amount of glass cleaner on a soft cloth to remove it. Wipe off all remaining liquid.

Note: Do not spray glass cleaner directly on the scanner glass. Make sure that no dust builds up on the surface of the scanner glass. Dust can cause spots in your scanned images.

Parent topic: [Cleaning and Transporting Your Scanner](#)

Transporting Your Scanner

If you need to ship your product, transport it a long distance, or store it for an extended period, prepare it for transportation as described here.

1. Make sure the carriage is in the home position on the upper side of the scanner. If the carriage is not in the home position, turn on the scanner and wait until the carriage moves to the home position.

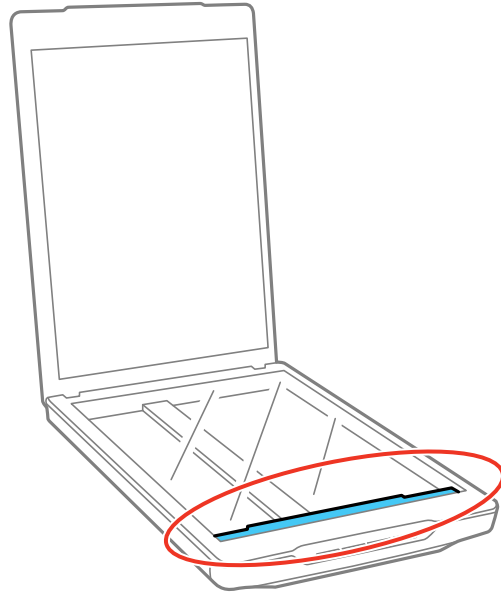

2. Disconnect the USB cable.
3. Place the scanner in its original packing materials if possible, or use equivalent materials with cushioning around the scanner.

Caution: Avoid turning the scanner upside down when transporting.

Parent topic: [Cleaning and Transporting Your Scanner](#)

Solving Problems

Check these sections for solutions to problems you may have using your product.

[Scanner Light Status](#)

[Solving Scanning Problems](#)

[Solving Scanned Image Quality Problems](#)

[Uninstall Your Scanner Software](#)

[Where to Get Help](#)

Scanner Light Status

You can often diagnose problems with your scanner by checking the status light.

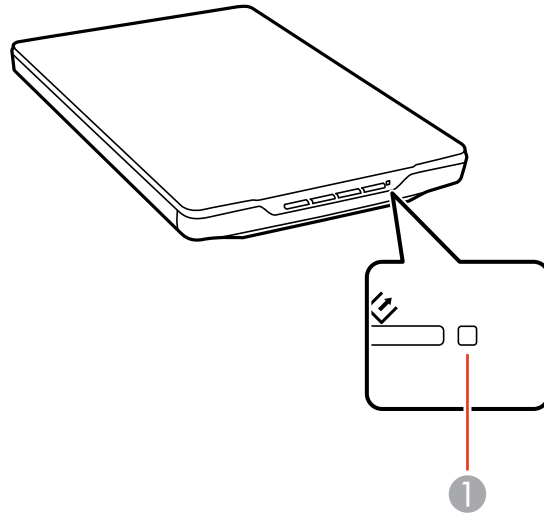

Light

1	The status light
---	------------------

Light status	Condition/solution
On	The scanner is turned on and ready to scan.
Flashing (1 second intervals)	The scanner is scanning or initializing. Wait for the status light to stop flashing before turning off the scanner.
Flashing rapidly (0.5 second intervals)	An error has occurred. Try the following: <ul style="list-style-type: none"> • Check the scanner connection to your computer to make sure it is secure. • Make sure your scanning software is installed correctly. • If the status light is still flashing, turn off the scanner, then turn it on again. If the error continues, the scanner may be malfunctioning. Contact Epson for support.
Off	The scanner is turned off.

Parent topic: [Solving Problems](#)

Solving Scanning Problems

Check these solutions if you have problems scanning with your product.

[Scanner Does Not Turn On or Turns Off Unexpectedly](#)

[Scanner Buttons Do Not Work as Expected](#)

[Scanning Software Does Not Operate Correctly](#)

[Cannot Start Epson Scan](#)

[Scanning is Slow](#)

[Cannot Scan Using Thumbnail Preview](#)

Parent topic: [Solving Problems](#)

Scanner Does Not Turn On or Turns Off Unexpectedly

If the scanner does not turn on or if it turns off unexpectedly, try these solutions:

- Make sure the USB cable is securely connected to the computer.
- Connect the scanner directly to the computer. The scanner may not work properly when connected through a USB hub.
- Use the USB cable that came with the scanner.
- Wait a few seconds for the scanner to turn on and the status light to stop blinking.

- If you are using a Mac and have another scanner connected to it (including an all-in-one product), the scanner will not power up automatically. Start Epson Scan to turn on the scanner.

Parent topic: [Solving Scanning Problems](#)

Related tasks

[Starting a Scan Using the Epson Scan Icon](#)

[Uninstalling Scanner Software - Windows](#)

[Uninstalling Scanner Software - Mac](#)

Scanner Buttons Do Not Work as Expected

If the scanner buttons do not start the correct program or perform the correct action, try these solutions:

- Make sure Epson Scan is installed correctly. If necessary, uninstall and reinstall it.
- Check the default settings assigned to the scanner buttons in Event Manager and change them, if necessary.
- With Windows Vista or Windows XP, check the settings in your scanner's Properties window:
 - **Windows Vista:** Open the  menu and select **Control Panel > Hardware and Sound > Scanners and Cameras**. Select the scanner and click **Properties**.
 - **Windows XP:** Double-click **My Computer**, right-click the scanner name, and select **Properties**.

Click the **Events** tab and make sure **Take no action** is not selected. Also make sure the scanner buttons are selected in the **Select an event** list box and that **Start this program** is selected.

Parent topic: [Solving Scanning Problems](#)

Related tasks

[Changing Default Scan Button Settings](#)

[Uninstalling Scanner Software - Windows](#)

[Uninstalling Scanner Software - Mac](#)

Scanning Software Does Not Operate Correctly

If your scanning software does not operate correctly, try these solutions:

- Make sure your computer has adequate memory and meets the system requirements for your operating system.
- Make sure your computer is not running in a power-saving mode, such as sleep or standby. If so, wake your system and restart your scanning software.
- Make sure the scanner is turned on.

- Make sure the connection between the scanner and your computer is secure.
- If you upgraded your operating system but did not reinstall your scanning software, try reinstalling it.
- In Windows, be sure that the scanner is listed under **Imaging Devices** in the Device Manager.
- Connect the scanner directly to the computer. The scanner may not work properly when connected through a USB hub.
- If you are using a TWAIN-compliant program, make sure that the correct product is selected as the **Scanner** or **Source** setting.

Parent topic: [Solving Scanning Problems](#)

Cannot Start Epson Scan

If you cannot start Epson Scan, try these solutions:

- Make sure your scanner is turned on and any interface cables are securely connected at both ends.
- Make sure Epson Scan is selected in your scanning program.
- Make sure your computer is not running in a power-saving mode, such as sleep or standby. If so, wake your system and restart Epson Scan.
- If you connected the scanner using a USB cable, make sure it is connected directly to your computer or through only one USB hub.
- Make sure you do not have multiple versions of Epson Scan installed. If you do, uninstall both versions and install one version.
- If you upgraded your operating system but did not reinstall Epson Scan, try reinstalling it.
- If you are using a TWAIN-compliant program, make sure that the correct product is selected as the **Scanner** or **Source** setting.

Parent topic: [Solving Scanning Problems](#)

Scanning is Slow

If scanning becomes slow, try these solutions:

- Scan your original at a lower resolution, if possible.
- Make sure your system meets the requirements for your operating system. If you are scanning a high-resolution image, you may need more than the minimum requirements. If necessary, increase your system's memory or reduce the resolution.

Parent topic: [Solving Scanning Problems](#)

Cannot Scan Using Thumbnail Preview

If you cannot scan using the thumbnail preview in Epson Scan, check the following:

- Make sure you are using Home Mode or Professional Mode.
- If you are using Home Mode, the **Document Type** must be set to **Photograph**.

Parent topic: [Solving Scanning Problems](#)

Related tasks

[Scanning in Home Mode](#)

[Scanning in Professional Mode](#)

Solving Scanned Image Quality Problems

Check these sections if a scanned image on your computer screen has a quality problem.

[Image Consists of a Few Dots Only](#)

[Line of Dots Appears in All Scanned Images](#)

[Straight Lines in an Image Appear Crooked](#)

[Image is Distorted or Blurry](#)

[Image Colors are Patchy at the Edges](#)

[Image is Too Dark](#)

[Back of Original Image Appears in Scanned Image](#)

[Ripple Patterns Appear in an Image](#)

[Image is Scanned Upside-Down](#)

[Scanned Image Colors Do Not Match Original Colors](#)

[Scan Area is Not Adjustable in Thumbnail Preview](#)

[Scanned Image Edges are Cropped](#)

[Characters are not Recognized During Conversion to Editable Text \(OCR\)](#)

Parent topic: [Solving Problems](#)

Image Consists of a Few Dots Only

If your scanned image consists only of a few dots, try these solutions:

- Make sure you placed your original for scanning facing the correct way.
- If you are scanning using the Epson Scan **Black & White** setting, adjust the **Threshold** setting and scan again.

Parent topic: [Solving Scanned Image Quality Problems](#)

Line of Dots Appears in All Scanned Images

If a line of dots appears in all your scanned images, try these solutions:

- Clean the scanner glass with a soft, dry, lint-free cloth or use a small amount of glass cleaner on the cloth, if necessary. Paper towels are not recommended.

Caution: Do not spray glass cleaner directly on the scanner glass.

- Make sure any interface cables are securely connected at both ends.

Parent topic: [Solving Scanned Image Quality Problems](#)

Straight Lines in an Image Appear Crooked

If straight lines in an original appear crooked in a scanned image, make sure to place your original straight when you scan it.

Parent topic: [Solving Scanned Image Quality Problems](#)

Image is Distorted or Blurry

If a scanned image appears distorted or blurry, try these solutions:

- Make sure your original is not wrinkled or warped. This may prevent the original from laying flat on the scanner glass.
- Do not move your original or your product during scanning.
- Place your product on a flat, stable surface that extends beyond its base in all directions.
- Adjust these Epson Scan settings (if available) and try scanning again:
 - Select the **Unsharp Mask** setting.
 - Adjust the **Auto Exposure** setting.
 - Increase the **Resolution** setting.

Parent topic: [Solving Scanned Image Quality Problems](#)

Image Colors are Patchy at the Edges

If you are scanning a thick or warped original, cover its edges with paper to block external light as you scan it.

Parent topic: [Solving Scanned Image Quality Problems](#)

Image is Too Dark

If your scanned image is too dark, try these solutions:

- Adjust these Epson Scan settings (if available) and try scanning again:
 - **Auto Exposure**
 - **Brightness**
 - **Histogram Adjustment**
- Click **Customize**, then select the Color tab and adjust these Epson Scan settings (if available)
 - **Display Gamma**
 - **Continuous Auto Exposure**
 - Click **Recommended Value** to return the **Auto Exposure Level** setting to its default value.
- Check the brightness and contrast settings of your computer monitor.

Parent topic: [Solving Scanned Image Quality Problems](#)

Back of Original Image Appears in Scanned Image

If an image from the back of a thin original appears in your scanned image, place a piece of black paper on the back of the original and scan it again.

Parent topic: [Solving Scanned Image Quality Problems](#)

Ripple Patterns Appear in an Image

You may see a ripple pattern (called a moiré) in scanned images of printed documents. This is caused by interference from differing pitches in the scanner's screen and your original's halftone screen. To reduce this effect, adjust these Epson Scan settings (if available) and try scanning again:

- Select the **Descreening** setting.
- Select a lower **Resolution** setting.

Parent topic: [Solving Scanned Image Quality Problems](#)

Image is Scanned Upside-Down

Your product scans using the **Auto Photo Orientation** setting. This setting checks the preview image for faces, the sky, and other features, and then correctly rotates the photo when it is scanned, if

necessary. If your photo is not oriented correctly using this option, deselect the **Auto Photo Orientation** setting and scan again.

Note: **Auto Photo Orientation** will not work when you scan newspapers, magazines, documents, illustrations, or line art, or images smaller than 2 inches (5.1 cm) on any side.

Parent topic: [Solving Scanned Image Quality Problems](#)

Scanned Image Colors Do Not Match Original Colors

Printed colors can never exactly match the colors on your computer monitor because printers and monitors use different color systems: monitors use RGB (red, green, and blue) and printers typically use CMYK (cyan, magenta, yellow, and black).

Check the color matching and color management capabilities of your computer, display adapter, and the software you are using to see if they are affecting the palette of colors you see on your screen.

To adjust the colors in your scanned image, adjust these Epson Scan settings (if available) and try scanning again:

- Change the **Image Type** setting and experiment with different combinations of the next settings.
- Adjust the **Tone Correction** setting.
- Adjust the **Auto Exposure** setting.
- Click **Customize**, then select the Color tab and adjust the **Display Gamma** setting to match your output device (monitor or printer).
- Select **JPEG (*.jpg)** or **TIFF (*.tif)** as the **Type** setting on the File Save Settings window. Click **Options** and select **Embed ICC Profile**.

Parent topic: [Solving Scanned Image Quality Problems](#)

Related tasks

[Selecting Scan File Settings](#)

Scan Area is Not Adjustable in Thumbnail Preview

If you cannot adjust the scan area while viewing a Thumbnail preview in Epson Scan, try these solutions:

- Create a scan area by drawing a marquee on your preview image and adjusting it as necessary.
- Adjust the thumbnail cropping area using the Thumbnail Cropping Area slider in preview mode.
- Switch to Normal preview mode, if available, and preview your image again.

Parent topic: [Solving Scanned Image Quality Problems](#)

Scanned Image Edges are Cropped

If the edges of a scanned image are cropped, make sure your original is placed correctly for scanning. If necessary, move your original away from the edges of the scanner glass slightly.

Parent topic: [Solving Scanned Image Quality Problems](#)

Related tasks

[Placing Originals on the Scanner Glass](#)

[Placing Originals While Using the Scanner Stand](#)

Characters are not Recognized During Conversion to Editable Text (OCR)

If characters in your scanned images are not recognized during OCR conversion, try these solutions:

- Make sure your original is straight.
- Adjust these Epson Scan settings (if available) and try scanning again:
 - Select **Text Enhancement**
 - Select the correct **Image Type** setting
 - Adjust the **Threshold** setting
- Set the scanning resolution between 200 and 600 dpi.
- If you are using OCR software, check the manual for any additional adjustments.

Parent topic: [Solving Scanned Image Quality Problems](#)

Uninstall Your Scanner Software

If you have a problem that requires you to uninstall and re-install your software, follow the instructions for your operating system.

[Uninstalling Scanner Software - Windows](#)



[Uninstalling Scanner Software - Mac](#)

Parent topic: [Solving Problems](#)

Uninstalling Scanner Software - Windows

You can uninstall and then re-install your scanner software to solve certain problems.

1. Turn off the scanner.
2. Disconnect any interface cables.

3. Do the following to uninstall each of your scanning software programs and follow any on-screen instructions:
 - **Windows 10:** Click  and select  (Settings) > **Apps > Apps & features**. Select the scanner software program and click **Uninstall**.
 - **Windows 8.x:** Navigate to the **Apps** screen and select **Control Panel > Programs > Programs and Features**. Select the scanner software program and click **Uninstall/Change**.
 - **Windows 7 or Windows Vista:** Open the Windows **Control Panel** utility. Select **Programs and Features**. (In Classic view, select **Programs** and click **Uninstall a program**.) Select the scanner software program and click **Uninstall/Change**.
 - **Windows XP:** Open the Windows **Control Panel** utility. Double-click **Add or Remove Programs**. Select the scanner software program and click **Change/Remove**.
4. Restart your computer, then see the *Start Here* sheet to re-install your software.

Note: If you find that re-installing your scanner software does not solve a problem, contact Epson.

Parent topic: [Uninstall Your Scanner Software](#)

Uninstalling Scanner Software - Mac

In most cases, you do not need to uninstall your scanner software before re-installing it. However, you can download the Uninstaller utility from the Epson support website to uninstall your scanner software as described here.

1. To download the Uninstaller utility, visit epson.com/support (U.S.), epson.ca/support (Canada), or epson.com.jm/support (Caribbean) and select your product.
2. Follow the instructions on the screen to install the Uninstaller utility.
3. Quit all applications currently running on your Mac.
4. Double-click the **Uninstaller** icon.
5. In the Epson Uninstaller screen, select the checkbox for each software program you want to uninstall.
6. Click **Uninstall**.
7. Follow the on-screen instructions to uninstall the software.
8. To reinstall your scanner software, see the *Start Here* sheet for instructions.

Note: If you find that re-installing your scanner software does not solve a problem, contact Epson.

Parent topic: [Uninstall Your Scanner Software](#)

Where to Get Help

If you need to contact Epson for technical support services, use the following support options.

Internet Support

Visit Epson's support website at epson.com/support (U.S.), epson.ca/support (Canada), or epson.com.jm/support (Caribbean) and select your product for solutions to common problems with your product. You can download utilities and documentation, get FAQs and troubleshooting advice, or e-mail Epson with your questions.

Speak to a Support Representative

Before you call Epson for support, please have the following information ready:

- Product name
- Product serial number (located on a label on the product)
- Proof of purchase (such as a store receipt) and date of purchase
- Computer configuration
- Description of the problem

Then call:

- U.S.: (562) 276-4382, 6 AM to 8 PM, Pacific Time, Monday through Friday, and 7 AM to 4 PM, Pacific Time, Saturday
- Canada: (905) 709-3839, 6 AM to 8 PM, Pacific Time, Monday through Friday, and 7 AM to 4 PM, Pacific Time, Saturday

Days and hours of support are subject to change without notice. Toll or long distance charges may apply.

Note: For help using any other software on your system, see the documentation for that software for technical support.

Purchase Supplies and Accessories

You can purchase genuine Epson accessories at epson.com (U.S. sales), epson.ca (Canadian sales), or epson.com.jm (Caribbean sales). You can also purchase accessories from an Epson authorized reseller. To find the nearest one, call 800-GO-EPSON (800-463-7766) in the U.S. or 800-807-7766 in Canada.

Parent topic: [Solving Problems](#)

Technical Specifications

These sections list the technical specifications for your scanner.

Note: Epson offers a recycling program for end of life Epson products. Please go to [this site](#) (U.S) or [this site](#) (Canada) for information on how to return your Epson products for proper disposal.

[Windows System Requirements](#)

[Mac System Requirements](#)

[General Specifications](#)

[Dimension Specifications](#)

[Electrical Specifications](#)

[Environmental Specifications](#)

[USB Interface Specifications](#)

[Safety and Approvals Specifications](#)

Windows System Requirements

Make sure your system meets these requirements before using it with your scanner.

System Microsoft Windows 10, 8.x, Windows 7, Windows Vista, Windows XP Service Pack 2 or later

Interface USB 2.0 (Type-B standard connector)

Parent topic: [Technical Specifications](#)

Mac System Requirements

Make sure your system meets these requirements before using it with your scanner.

System macOS 10.15.x or earlier; OS X 10.10.x, 10.9.x, 10.8.x, 10.7.x, 10.6.x

(Fast user switching on OS X is not supported.)

Interface Macintosh USB

Note: Epson Scan does not support the UNIX File System (UFS) for OS X. Install Epson Scan on a disk or in a partition that does not use UFS.

Parent topic: [Technical Specifications](#)

General Specifications

Scanner type	Flatbed, color
Photoelectric device	CIS
Effective pixels	40800 × 56160 pixels at 4800 dpi Scanning area may be restricted if resolution setting is large.
Document size	Maximum: 8.5 × 11.7 inches (216 × 297 mm); US letter or A4
Scanning resolution	4800 dpi (main scan) 4800 dpi (sub scan)
Output resolution	50 to 4800, 7200, and 9600 dpi (50 to 4800 dpi in 1 dpi increments)
Image data	16 bits per pixel per color internal 8 bits per pixel per color external
Interface	One Hi-Speed USB port
Light source	LED

Parent topic: [Technical Specifications](#)

Dimension Specifications

Height	1.6 inches (39 mm)
Width	9.9 inches (249 mm)
Depth	14.4 inches (364 mm)
Weight	3.4 lb (1.5 kg)

Parent topic: [Technical Specifications](#)

Electrical Specifications

Note: Check the label on the scanner for voltage information.

Power supply	USB bus power
Rated input voltage	DC 5 V
Rated input current	500 mA
Power consumption	Operating: 2.5 W Ready mode: 1.1 W Power off mode: 0.0125 W

Parent topic: [Technical Specifications](#)

Environmental Specifications

Temperature	Operating: 50 to 95 °F (10 to 35 °C) Storage: –4 to 140 °F (–20 to 60 °C)
Humidity (non-condensing)	Operating: 20 to 80% RH Storage: 20 to 80% RH
Operating conditions	Ordinary office or home conditions

Note: Avoid operating the scanner in direct sunlight, near a strong light source, or in extremely dusty conditions.

Parent topic: [Technical Specifications](#)

USB Interface Specifications

Interface type	Universal Serial Bus Specifications Revision 2.0
Electrical standard	Full Speed mode (12 Mbits per second) and Hi-Speed mode (480 Mbits per second) of Universal Serial Bus Specifications Revision 2.0
Connector type	One Micro-B port

Parent topic: [Technical Specifications](#)

Safety and Approvals Specifications

United States

EMC: FCC part 15 Subpart B class B

Canada

EMC: CAN/CSA-CEI/IEC CISPR 22 Class B

Parent topic: [Technical Specifications](#)

Notices

Check these sections for important notices about your scanner.

Note: Epson offers a recycling program for end of life Epson products. Please go to [this site](#) (U.S) or [this site](#) (Canada) for information on how to return your Epson products for proper disposal.

[Important Safety Instructions](#)

[Default Delay Times for Power Management for Epson Products](#)

[Restrictions on Copying](#)

[Trademarks](#)

[Copyright Notice](#)

Important Safety Instructions

Follow these safety instructions when setting up and using the scanner:

- Read all these instructions, and follow all warnings and instructions marked on the scanner.
- Place the scanner close enough to the computer for the interface cable to reach it easily.
- Do not use with wet hands.
- When connecting this product to a computer or other device with a cable, ensure the correct orientation of the connectors. Each connector has only one correct orientation. Inserting a connector in the wrong orientation may damage both devices connected by the cable.
- Do not insert objects into any opening as they may touch dangerous voltage points or short out parts. Beware of electrical shock hazards.
- Place the product on a flat, stable surface that extends beyond the base of the product in all directions. If you place the product by the wall, leave at least 3.9 inches (10 cm) between the back of the product and the wall.
- After replacing consumable parts, dispose of them correctly following the rules of your local authority. Do not disassemble them.
- Do not place or store the scanner outdoors, in a car, near excessive dirt or dust, water, heat sources, or in locations subject to shocks, vibrations, condensation, high temperature or humidity, direct sunlight, strong light sources, or rapid changes in temperature or humidity.
- Never disassemble, modify, or attempt to repair the scanner or a scanner option by yourself except as specifically explained in this guide.

Warning: The cords included with this product contain chemicals, including lead, known to the State of California to cause birth defects or other reproductive harm. **Wash hands after handling.** (This notice is provided in accordance with Proposition 65 in Cal. Health & Safety Code § 25249.5 and following.)

USB

- The USB cable should be placed to avoid abrasions, cuts, fraying, crimping, and kinking.
- Do not place objects on top of the USB cable and do not allow the cable to be stepped on or run over. Be particularly careful to keep the USB cable straight at the end.
- If you are not going to use the product for a long period, unplug the USB cable from the computer.
- Unplug the scanner and the USB cable, and refer servicing to qualified service personnel under the following conditions: Liquid has entered the scanner; the scanner has been dropped or the case has been damaged; the scanner does not operate normally or exhibits a distinct change in performance. (Do not adjust controls that are not covered by the operating instructions.)

Parent topic: [Notices](#)

Default Delay Times for Power Management for Epson Products

This product will enter sleep mode after a period of nonuse. The time interval has been set at the factory to ensure that the product meets Energy Star standards of energy efficiency, and cannot be modified by the consumer.

Parent topic: [Notices](#)

Restrictions on Copying

Observe the following restrictions to ensure responsible and legal use of your scanner.

Copying of the following items is prohibited by law:

- Bank bills, coins, government-issued marketable securities, government bond securities, and municipal securities
- Unused postage stamps, pre-stamped postcards, and other official postal items bearing valid postage
- Government-issued revenue stamps, and securities issued according to legal procedure

Exercise caution when copying the following items:

- Private marketable securities (stock certificates, negotiable notes, checks, etc.), monthly passes, concession tickets, etc.
- Passports, driver's licenses, warrants of fitness, road passes, food stamps, tickets, etc.

Note: Copying these items may also be prohibited by law.

Restriction on disassembling and decompiling

You may not disassemble, decompile, or otherwise attempt to derive the source code of any software included with this product.

Parent topic: [Notices](#)

Trademarks

EPSON® and Perfection® are registered trademarks and EPSON Exceed Your Vision is a registered logomark of Seiko Epson Corporation.

Mac, Macintosh, and OS X are trademarks of Apple Inc., registered in the U.S. and other countries.

Google Drive and Picasa are trademarks of Google LLC.

General Notice: Other product names used herein are for identification purposes only and may be trademarks of their respective owners. Epson disclaims any and all rights in those marks.



Parent topic: [Notices](#)

Copyright Notice

All rights reserved. No part of this publication may be reproduced, stored in a retrieval system, or transmitted in any form or by any means, electronic, mechanical, photocopying, recording, or otherwise, without the prior written permission of Seiko Epson Corporation. The information contained herein is designed only for use with this Epson product. Epson is not responsible for any use of this information as applied to other products.

Neither Seiko Epson Corporation nor its affiliates shall be liable to the purchaser of this product or third parties for damages, losses, costs, or expenses incurred by purchaser or third parties as a result of: accident, misuse, or abuse of this product or unauthorized modifications, repairs, or alterations to this product, or (excluding the U.S.) failure to strictly comply with Seiko Epson Corporation's operating and maintenance instructions.

Seiko Epson Corporation shall not be liable for any damages or problems arising from the use of any options or any consumable products other than those designated as Original Epson Products or Epson Approved Products by Seiko Epson Corporation.

Seiko Epson Corporation shall not be held liable for any damage resulting from electromagnetic interference that occurs from the use of any interface cables other than those designated as Epson approved Products by Seiko Epson Corporation.

This information is subject to change without notice.

[libTIFF Software Acknowledgment](#)

[A Note Concerning Responsible Use of Copyrighted Materials](#)

[Copyright Attribution](#)

Parent topic: [Notices](#)

libTIFF Software Acknowledgment

Copyright © 1988-1997 Sam Leffler

Copyright © 1991-1997 Silicon Graphics, Inc.

Permission to use, copy, modify, distribute, and sell this software and its documentation for any purpose is hereby granted without fee, provided that (i) the above copyright notices and this permission notice appear in all copies of the software and related documentation, and (ii) the names of Sam Leffler and Silicon Graphics may not be used in any advertising or publicity relating to the software without the specific, prior written permission of Sam Leffler and Silicon Graphics.

THE SOFTWARE IS PROVIDED "AS-IS" AND WITHOUT WARRANTY OF ANY KIND, EXPRESS, IMPLIED OR OTHERWISE, INCLUDING WITHOUT LIMITATION, ANY WARRANTY OF MERCHANTABILITY OR FITNESS FOR A PARTICULAR PURPOSE.

IN NO EVENT SHALL SAM LEFFLER OR SILICON GRAPHICS BE LIABLE FOR ANY SPECIAL, INCIDENTAL, INDIRECT OR CONSEQUENTIAL DAMAGES OF ANY KIND, OR ANY DAMAGES WHATSOEVER RESULTING FROM LOSS OF USE, DATA OR PROFITS, WHETHER OR NOT ADVISED OF THE POSSIBILITY OF DAMAGE, AND ON ANY THEORY OF LIABILITY, ARISING OUT OF OR IN CONNECTION WITH THE USE OR PERFORMANCE OF THIS SOFTWARE.

Parent topic: [Copyright Notice](#)

A Note Concerning Responsible Use of Copyrighted Materials

Epson encourages each user to be responsible and respectful of the copyright laws when using any Epson product. While some countries' laws permit limited copying or reuse of copyrighted material in certain circumstances, those circumstances may not be as broad as some people assume. Contact your legal advisor for any questions regarding copyright law.

Parent topic: [Copyright Notice](#)

Copyright Attribution

© 2020 Epson America, Inc.

2/20

CPD-42186R2

Parent topic: [Copyright Notice](#)